

Jansen-Economy 60 Türen

Türen aus Stahl

Portes Jansen-Economy 60

Portes en acier

Jansen-Economy 60 doors

Doors in steel

Systemübersicht

Merkmale
Leistungseigenschaften
Systemausführungen
Typenübersicht

Sommaire du système

Caractéristiques
Caractéristiques de performance
Exécutions de système
Sommaire des types

Summary of system

Characteristics
Performance characteristics
System versions
Summary of types

2

Profilsortiment

Assortiment de profilé

Range of profiles

14

Beispiele

Schnittpunkte
Konstruktionsdetails
Anschlüsse am Bau

Exemples

Coupes de détails
Détails de construction
Raccords au mur

Examples

Section details
Construction details
Attachment to structure

18

Leistungseigenschaften

Caractéristiques de performance

Performance characteristics

36

Alle Ausführungen dieser Dokumentation haben wir sorgfältig und nach bestem Wissen zusammengestellt. Wir können aber keine Verantwortung für die Benutzung der vermittelten Vorschläge und Daten übernehmen. Wir behalten uns technische Änderungen ohne Vorankündigung vor.
Aktuelle Version auf www.jansen.com

Nous avons apporté le plus grand soin à l'élaboration de cette documentation. Cependant, nous déclinons toute responsabilité pour l'utilisation faite de nos propositions et de nos données.
Nous nous réservons le droit de procéder à des modifications techniques sans préavis.
Version actuelle sur www.jansen.com

All the information contained in this documentation is given to the best of our knowledge and ability. However, we decline all responsibility for the use made of these suggestions and data.
We reserve the right to effect technical modifications without prior warning.
Current version available at www.jansen.com







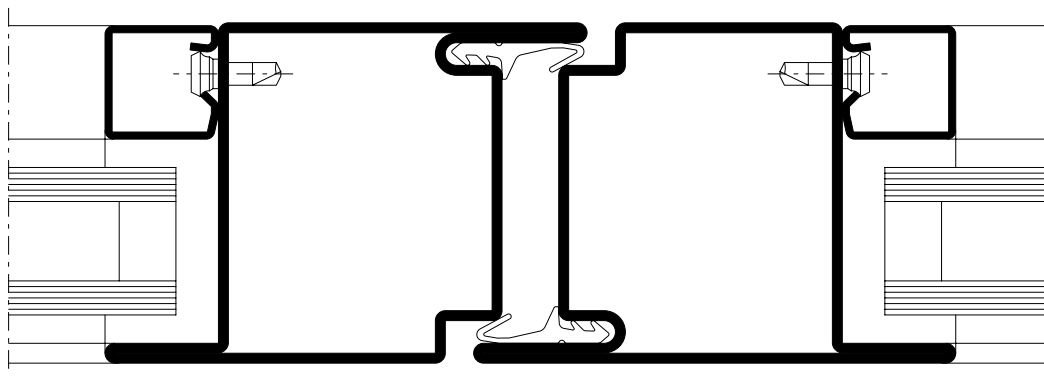

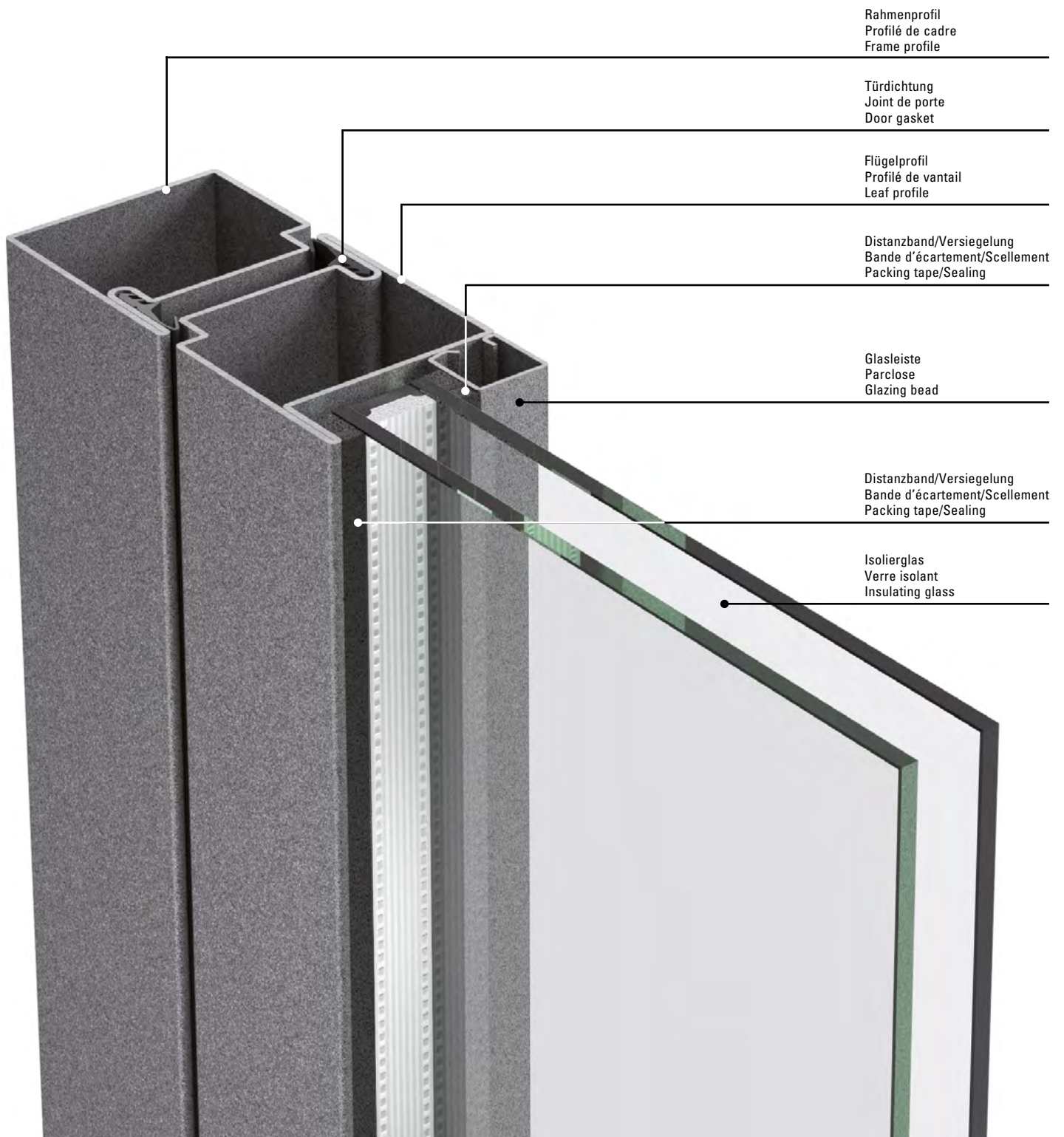

Merkmale
Caractéristiques
Characteristics

Jansen-Economy 60 Türen
Jansen-Economy 60 portes
Jansen-Economy 60 doors

- Stahlsystem für Türen und Festverglasungen
- Bautiefe 60 mm, innen und aussen flächenbündig
- Schmale Ansichtsbreiten: Rahmen und Flügel ab 105 mm Stulppartie 150 mm
- Ein- und zweiflüglige Türen, nach innen und aussen öffnend, mit Oberlicht oder Festverglasung kombinierbar
- Türflügel bis 1465 x 3000 mm (BxH), Flügelgewicht bis 230 kg
- Füllelementstärke von 5 bis 36 mm, Glaseinbau mittels Trocken- oder Nassverglasung
- Systemprüfungen nach Produktnorm EN 14351-1
- Stahlprofile blank oder bandverzinkt
- Grosses Sortiment an systemgeprüften Türbeschlägen
- Barrierefreie Schwellenausbildungen
- Geeignet für Pulver- und Nasslackbeschichtungen
- Système en acier pour portes et vitrages fixes
- Profondeur de montage 60 mm, montage à fleur à l'intérieur et à l'extérieur
- Fines largeurs de face: Cadre et vantaux à partir de 105 mm Partie tête 150 mm
- Portes à un et deux vantaux, ouverture vers l'intérieur et vers l'extérieur, combinables avec imposte ou vitrage fixe
- Vantaux de porte jusqu'à 1465 x 3000 mm (LaxH), poids du vantail jusqu'à 230 kg
- Élément de remplissage de 5 à 36 mm d'épaisseur, Montage du vitrage à sec ou à silicone
- Contrôles des systèmes selon la norme produit EN 14351-1
- Profilés en acier brut ou galvanisé en continu
- Grand assortiment de ferrures de porte homologuées
- Formes de seuil sans barrière
- Convient aux revêtements par poudre ou peinture liquide
- Steel system for doors and fixed glazing
- 60 mm basic depth, flush-fitted on the inside and outside
- Narrow face widths: Frame and leaf from 105 mm Meeting stile assembly 150 mm
- Single and double-leaf doors, inward and outward-opening, can be combined with toplight or fixed glazing
- Door leaf up to 1465 x 3000 mm (WxH), leaf weight up to 230 kg
- Infill unit thickness of 5 to 36 mm, Glazing installed by means of dry or wet glazing
- System tests in accordance with the product standard EN 14351-1
- Raw finish or pre-galvanised steel profiles
- Large range of system-tested door fittings
- Easy-access thresholds
- Suitable for powder and wet paint coating





Norm	Eigenschaft Caractéristique Characteristic	Klassifizierung/Wert Classification / Valeur Classification / Value										
 EN 12210	Widerstandsfähigkeit bei Windlast Résistance à la pression du vent Resistance to wind load	npd	1 (400)	2 (800)	3 (1200)	4 (1600)	5 (2000)	Exxx (>2000)				
 EN 12208	Schlagregendichtheit Étanchéité à la pluie battante Watertightness	npd	1A (0)	2A (50)	3A (100)	4A (150)	5A (200)	6A (250)	7A (300)	8A (450)	9A (600)	Exxx (>750)
 EN ISO 10140	Schalldämmung R_w (C, C_{tr}) (dB) Isolation phonique R_w (C, C_{tr}) (dB) Sound insulation R_w (C, C_{tr}) (dB)	npd	bis R_w 44 dB (-2; -5) jusqu'à R_w 44 dB (-2; -5) up to R_w 44 dB (-2; -5)									
 EN ISO 10077-2	Wärmedurchgangskoeffizient U_f (W/(m ² ·K)) Transmission thermique U_f (W/(m ² ·K)) Thermal production U_f (W/(m ² ·K))	npd	ab 5.65 W/m ² K à partir de 5.65 W/m ² K from 5.65 W/m ² K									
 EN 12207	Luftdurchlässigkeit Perméabilité à l'air Air permeability	npd	1 (150)		2 (300)		3 (600)		4 (600)			
 EN 1192	Klassifizierung der Festigkeitsanforderungen Classification des exigences de résistance méca. Classification of strength requirements	npd	1		2		3		4			
 EN 1627	Einbruchhemmung Anti-effraction Burglar resistance	npd	1		2		3		4		5	6
 EN 1522	Durchschusshemmung Résistance aux balles Bullet proofing	npd	FB1	FB2	FB3	FB4	FB5	FB6	FB7	FSG		
 EN 1191 EN 1603	Dauerfunktionsprüfung Durabilité mécanique Mechanical durability	D	1 5'000	2 10'000	3 20'000	4 50'000	5 100'000	6 200'000	7 500'000	8 1'000'000		
 EN 179 EN 1125	Fähigkeit zur Freigabe Capacité au déclenchement Ability to release		Anforderung erfüllt Exigence remplie Requirement fulfilled									

Norm	Eigenschaft Caractéristique Characteristic	Klassifizierung/Wert Classification / Valeur Classification / Value			
 EN 12217	Bedienkräfte Forces de manœuvre Operating forces	npd	0	1	2
 EN 1634-3 DIN 18095	Rauchschutz Étanchéité à la fumée Smoke control	S _a / S ₂₀₀ / RS			
 EN 16034 EN 13501-2	Selbstschliessung Fermeture automatique Self-closing	C			
 EN 16034	Dauerhaftigkeit der Selbstschliessung gegenüber Alterung (Korrosion) Endurance de la fermeture automatique contre le vieillissement (corrosion) Durability of self-closing against ageing (corrosion)	erzielt atteinte achieved			

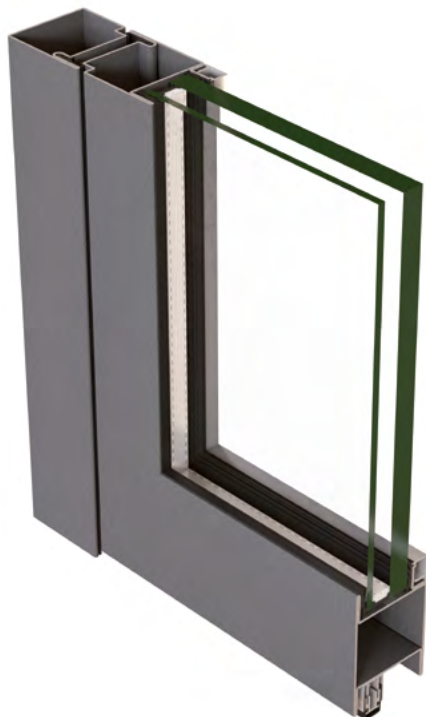

Einbruchhemmende Jansen-Economy 60 Türen

- Türflügelgrößen 1465 x 3000 mm
- Ein- und zweiflügelige Türen, nach innen und aussen öffnend
- Geprüft nach EN 1627
- Panik- und Normalausführung

Portes anti-effraction Jansen-Economy 60

- Dimensions de vantail de porte 1465 x 3000 mm
- Portes à un/deux vantaux à ouverture vers l'intérieur et l'extérieur
- Contrôlé selon la norme EN 1627
- Exécution panique et exécution normale

Burglar-resistant Jansen Economy 60 doors

- Door leaf sizes 1465 x 3000 mm
- Single and double-leaf doors, inward and outward opening
- Tested in accordance with EN 1627
- Panic and standard design



Durchschusshemmende Jansen-Economy 60 Türen

- Türflügelgrößen 1465 x 3000 mm
- Ein- und zweiflügelige Türen, nach innen und aussen öffnend
- Geprüft nach EN 1522

Portes pare-balles Jansen-Economy 60

- Dimensions de vantail de porte 1465 x 3000 mm
- Portes à un/deux vantaux à ouverture vers l'intérieur et l'extérieur
- Contrôlé selon la norme EN 1522

Bullet-resistant Jansen Economy 60 doors

- Door leaf sizes 1465 x 3000 mm
- Single and double-leaf doors, inward and outward opening
- Tested in accordance with EN 1522



Fluchttürsysteme

- Verschlussystem für Notausgangstüren nach EN 179
- Verschlussystem für Paniktüren nach EN 1125
- Barrierefreie Türen ohne Schwelle für behindertengerechtes Bauen
- Ein- und zweiflügelige Türen nach innen und aussen öffnend
- Türflügelgrößen bis 1465 x 3000 mm und Flügelgewicht bis 230 kg

Systèmes de porte de secours

- Système de fermeture pour portes de secours selon EN 179
- Système de fermeture pour portes panique selon EN 1125
- Portes sans seuil pour faciliter l'accès aux personnes handicapées
- Portes à un/deux vantaux à ouverture vers l'intérieur et l'extérieur
- Dimensions de vantail de porte jusqu'à 1465 x 3000 mm et poids de vantail jusqu'à 230 kg

Emergency exit systems

- Closing system for emergency exit doors in accordance with EN 179
- Closing system for panic doors in accordance with EN 1125
- Barrier-free doors without threshold for accessible buildings
- Single and double-leaf doors, inward and outward opening
- Door leaf sizes up to 1465 x 3000 mm and leaf weight up to 230 kg

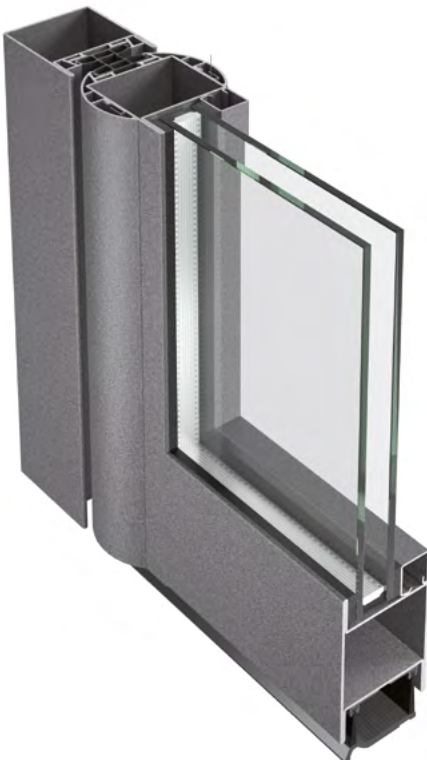

Jansen-Economy 60 Fingerschutzüren

- Keine Quetsch- und Scherstellen nach DIN 18650
- Wartungsarme Bandlager unten und oben
- Geeignet für Gebäude mit starkem Publikumsverkehr
- Geprüft nach EN 14351-1

Portes anti-pince-doigts Jansen-Economy 60

- Absence de zones d'écrasement et de cisaillement selon DIN 18650
- Paliers de paumelle inférieur et supérieur exigeant peu de maintenance
- Adapté à des bâtiments publics fortement fréquentés
- Contrôlé selon la norme EN 14351-1

Jansen Economy 60 anti-finger-trap doors

- No crushing and shearing points as per DIN 18650
- Low-maintenance hinge bush at top and bottom
- Suitable for buildings subject to frequent use by the public
- Tested in accordance with EN 14351-1



Verblechte Jansen-Economy 60 Türen

- Flächenbündig verblechte Türen
- Geschweisst oder geklebt
- Nach innen und aussen öffnend
- Mit Glasausschnitt möglich

Portes tôlées Jansen-Economy 60

- Portes tôlées à fleur
- Soudées ou collées
- Ouverture vers l'intérieur et l'extérieur
- Panneau de verre possible

Jansen Economy 60 sheet metal doors

- Flush-fitted sheet metal doors
- Welded or bonded
- Inward and outward-opening
- Can have glass vision panel



Jansen-Economy 60 faltwand

- Nach innen und aussen öffnend
- Leichtgängige, geräuscharme Bedienung
- Schwellenlose Ausführung
- Flügelgewichte bis 100 kg

Porte repliable Jansen-Economy 60

- Ouverture vers l'intérieur et l'extérieur
- Mobilité silencieuse
- Exécution sans seuil
- Poids de vantail jusqu'à 100 kg

Jansen Economy 60 folding wall

- Inward and outward-opening
- Smooth and quiet operation
- Design without a threshold
- Vent weights up to 100 kg

Jansen Docu Center

Die Plattform zum effizienten Arbeiten mit Jansen Dokumentationen. Im Jansen Docu Center stehen alle Produktinformationen jederzeit digital in der aktuellsten Version zur Verfügung: von Architekten-Informationen über Bestell- und Fertigungskatalogen bis hin zu Anleitungen und Prospekten sowie Videos.

Die Inhalte können einfach und schnell aufgerufen werden. Ein für den Anwender komfortables papierloses Arbeiten, das zahlreiche Vorteile bietet.

Jansen Docu Center

La plate-forme pour travailler efficacement avec les documentations Jansen. Le Jansen Docu Center met à votre disposition les informations sur les produits, en format numérique et dans une version actualisée: des catalogues de commande et de fabrication aux instructions et prospectus, en passant par les informations destinées aux architectes et vidéos.

Les contenus sont facilement et rapidement accessibles. Une manière de travailler confortable et offrant de nombreux avantages.

Jansen Docu Center

The platform for working efficiently with Jansen documentation. The latest version of all the product information is available digitally at any time in the Jansen Docu Center – from order and fabrication manuals to architect information, instructions and brochures and videos.

The content can be retrieved quickly and easily. The user can work conveniently without paper, which has numerous benefits.

Download CAD Daten

DXF

DWG

Sie können die Zeichnungen in den Formaten DXF und/oder DWG herunterladen. Klicken Sie auf das entsprechende Icon und der Download erfolgt.

Die Hinweise «Artikelbibliothek/Türbeschläge/Fensterbeschläge» bedeuten, dass Sie mit einem Klick die gesamte Artikelbibliothek des entsprechenden Systems herunterladen (Profile, Beschläge, Glasleisten, Zubehör etc.).

Info und Beratung

Gerne beraten wir Sie persönlich und stehen Ihnen bei Fragen zur Verfügung. Bitte schreiben Sie uns Ihre Anliegen an: info@jansen.com

Télécharger fichiers DAO

DXF

DWG

Vous pouvez télécharger les dessins aux formats DXF et/ou DWG. Cliquez sur l'icône correspondante et le téléchargement s'effectuera.

Les indications «Bibliothèque des articles/Ferures de porte/Ferrures de fenêtres» signifie que vous téléchargez la totalité de la bibliothèque des articles du système donné (profilés, ferrures, parclofes, accessoires etc.).

Info et conseils

Nous vous conseillerons volontiers individuellement et sommes à votre disposition si vous avez des questions à poser. Veuillez nous envoyer votre requête à: info@jansen.com

Download CAD files

DXF

DWG

You can download the drawings in DXF and/or DWG format. Click on the relevant icon to begin the download.

The items «Article library/Door fittings/Window fittings» means that you download the entire article library for the corresponding system with one click (profiles, fittings, glazing beads, accessories etc.).

Information and advice

We would be delighted to provide you with advice in person and are available to answer any questions you may have. Please write to us with your queries at: info@jansen.com

Zulassungen/Prüfungen
Homologations/Essais
Authorisations/Tests

Jansen-Economy 60 Türen
Jansen-Economy 60 portes
Jansen-Economy 60 doors

Elementgrößen
(Empfehlung für CE-Kennzeichnung)

Dimensions des éléments
(Recommandation pour le label CE)

Size of elements
(Recommendation for CE marking)

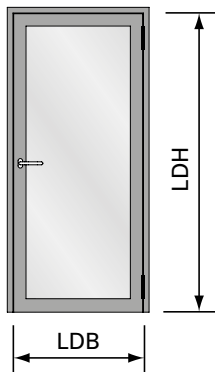

LDB Lichte Durchgangsbreite
max. 1425 mm
min. 490 mm

LDB Largeur vide lumière
max. 1425 mm
min. 490 mm

LDB Clear opening width
max. 1425 mm
min. 490 mm

LDH Lichte Durchgangshöhe
max. 2988 mm
min. 1900 mm

LDH Hauteur vide lumière
max. 2988 mm
min. 1900 mm

LDH Clear opening height
max. 2988 mm
min. 1900 mm

Flügelgewicht max. 230 kg

Poids de vantail max. 230 kg

Weight of leaf max. 230 kg

Zulassungen/Prüfungen
Homologations/Essais
Authorisations/Tests

Jansen-Economy 60 Türen
Jansen-Economy 60 portes
Jansen-Economy 60 doors

Elementgrößen
(Empfehlung für CE-Kennzeichnung)

Dimensions des éléments
(Recommandation pour le label CE)

Size of elements
(Recommendation for CE marking)

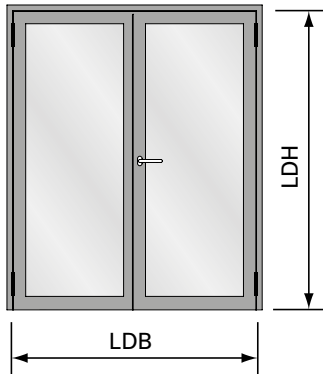

LDB Lichte Durchgangsbreite
max. 2850 mm
min. 1000 mm

LDB Largeur vide lumière
max. 2850 mm
min. 1200 mm

LDB Clear opening width
max. 2850 mm
min. 1000 mm

LDH Lichte Durchgangshöhe
max. 2988 mm
min. 1900 mm

LDH Hauteur vide lumière
max. 2988 mm
min. 1900 mm

LDH Clear opening height
max. 2988 mm
min. 1900 mm

Flügelgewicht max. 230 kg

Poids de vantail max. 230 kg

Weight of leaf max. 230 kg

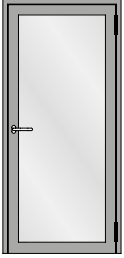

Einflügelige Türe
Porte à un vantail
Single leaf door

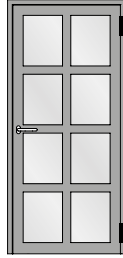

Einflügelige Türe mit Riegel
Porte à un vantail avec traverse
Single leaf door with transom

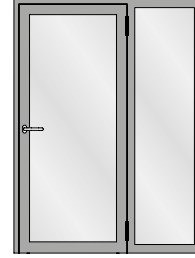

Einflügelige Türe mit Seitenteil
Porte à un vantail avec partie latérale
Single leaf door with side light

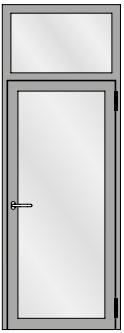

Einflügelige Türe mit Oberlicht
Porte à un vantail avec imposte
Single leaf door with top light

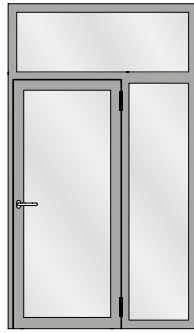

Einflügelige Türe mit Seitenteil und Oberlicht
Porte à un vantail avec avec partie latérale
et imposte
Single leaf door with side light and top light

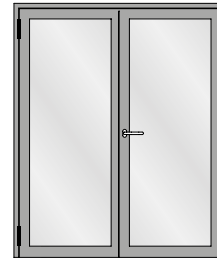

Zweiflügelige Türe
Porte à deux vantaux
Double leaf door



Zweiflügelige Türe mit zwei Seitenteilen
Porte à deux vantaux avec deux parties latérales
Double leaf door with two side lights

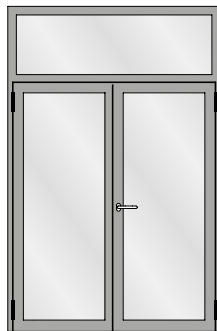

Zweiflügelige Türe mit Oberlicht
Porte à deux vantaux avec imposte
Double leaf door with top light

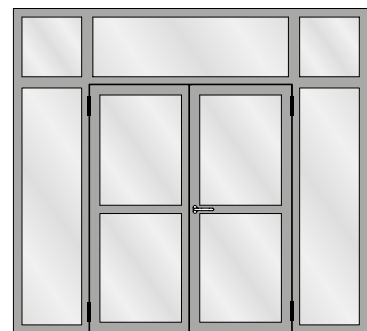

Zweiflügelige Türe mit zwei Seitenteilen und Oberlichtern
Porte à deux vantaux avec deux parties latérales et impostes
Double leaf door with two side lights and top lights

Typenübersicht
Sommaire des types
Summary of types

Jansen-Economy 60 Türen
Jansen-Economy 60 portes
Jansen-Economy 60 doors

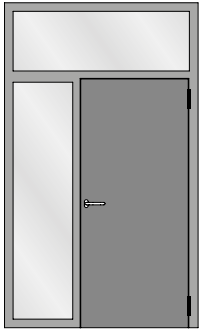

Verblechte Türe mit Seitenteil und Oberlicht
Porte tôlée à un vantail avec avec partie latérale
et imposte
Sheet metal single leaf door with side light
and top light



Verblechte zweiflügelige Türe mit zwei
Seitenteilen und Oberlichtern
Porte tôlée à deux vantaux avec deux parties
latérales et impostes
Sheet metal double leaf door with two side
lights and top lights



Festverglasung
Vitrage fixe
Fixed glazing

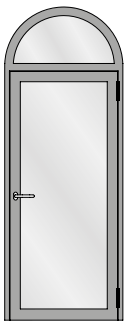

Einflügelige Türe mit Rundbogen-Oberlicht
Porte à un vantail avec imposte demi-ronde
Single leaf door with round arched top light

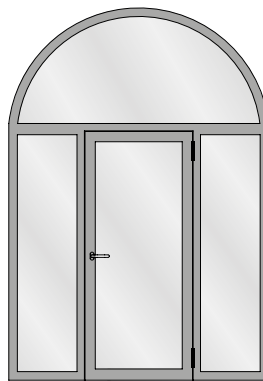

Einflügelige Türe mit zwei Seitenteilen und
Rundbogen-Oberlicht
Porte à un vantail avec deux parties latérales
et imposte demi-ronde
Single leaf door with two side lights and
round arched top light

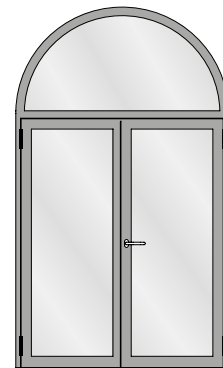

Zweiflügelige Türe mit Rundbogen-Oberlicht
Porte à deux vantaux avec imposte demi-ronde
Double leaf door with round arched top light

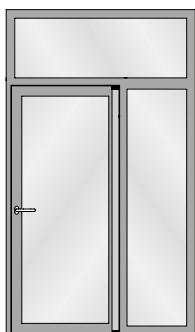

Fingerschutztüre
Porte anti-pince-doigts
Anti-finger-trap door

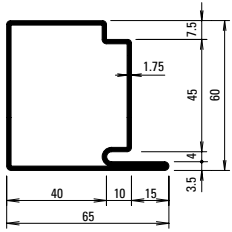

30.019
30.019 Z

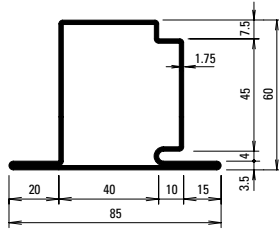

30.119
30.119 Z

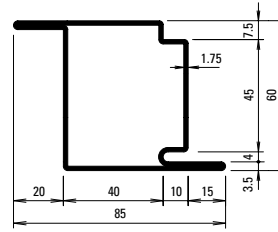

30.419
30.419 Z

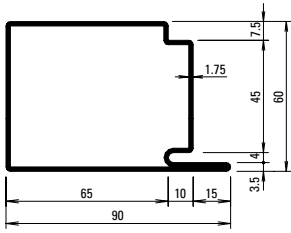

30.017
30.017 Z

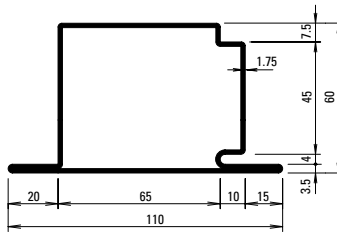

30.117
30.117 Z

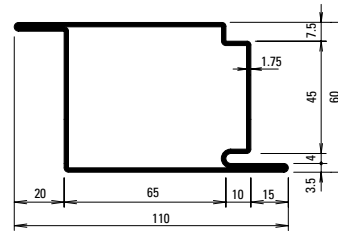

30.415

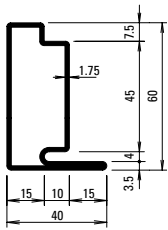

30.018
30.018 Z

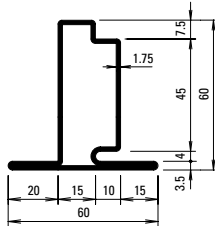

30.118
30.118 Z

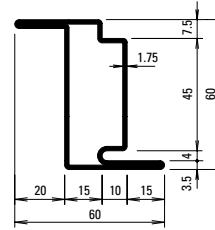

30.418
30.418 Z

Oberfläche/Werkstoff

Artikel-Nr.

ohne Zusatz = blank

mit Z = bandverzinkter Stahl

Surface/Matériau

No. d'article

sans supplément = brut

avec Z = bande d'acier zinguée

Surface/Material

Part no.

without addition = bright

with Z = strip galvanised steel

Profil-Nr.	G kg/m	F cm ²	I _x cm ⁴	W _x cm ³	I _y cm ⁴	W _y cm ³	U m ² /m
30.017	4,200	5,36	31,32	9,09	48,57	10,35	0,312
30.018	2,830	3,61	15,95	4,35	4,77	1,93	0,212
30.019	3,520	4,48	23,69	6,70	19,75	5,55	0,262
30.117	4,750	6,04	34,75	9,35	65,74	11,51	0,350
30.118	3,370	4,29	18,64	4,65	8,26	2,75	0,250
30.119	4,050	5,16	26,80	6,99	29,12	6,58	0,300

Profil-Nr.	G kg/m	F cm ²	I _x cm ⁴	W _x cm ³	I _y cm ⁴	W _y cm ³	U m ² /m
30.415	4,750	6,04	37,79	12,28	65,74	11,51	0,350
30.418	3,370	4,29	22,92	7,37	8,62	2,75	0,250
30.419	4,050	5,16	30,36	9,82	29,12	6,58	0,300

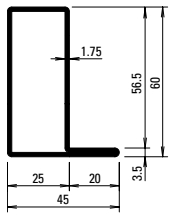

01.634
01.634 Z

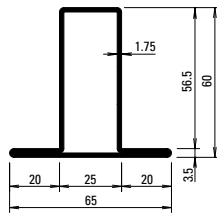

02.634
02.634 Z

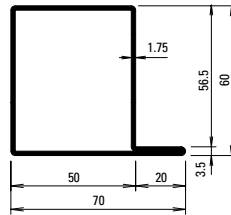

01.684
01.684 Z

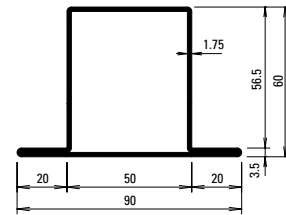

02.684
02.684 Z

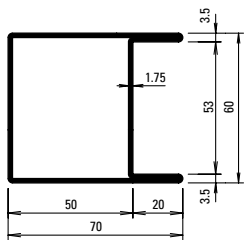

04.637
04.637 Z

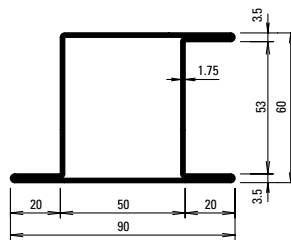

05.637
05.637 Z

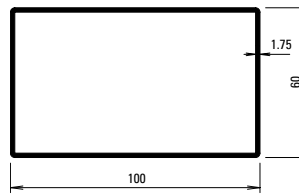

400.051
400.051 Z

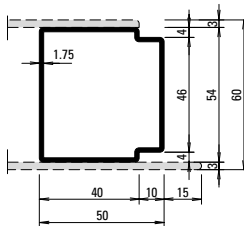

81.010
81.010 Z

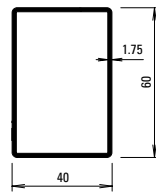

400.052
400.052 Z

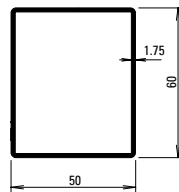

400.054
400.054 Z

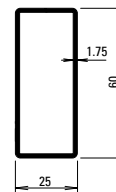

400.055
400.055 Z

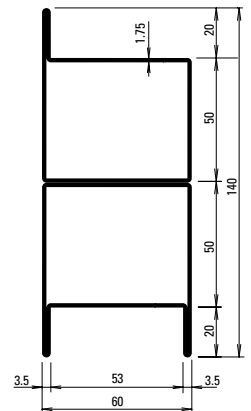

05.001

Profil-Nr.	G kg/m	F cm ²	I _x cm ⁴	W _x cm ³	I _y cm ⁴	W _y cm ³	U m ² /m
01.634	2,730	3,48	16,71	4,71	6,04	2,15	0,204
02.634	3,270	4,17	19,66	5,01	10,34	3,18	0,243
01.684	3,430	4,37	24,34	7,07	22,12	5,59	0,255
02.684	3,960	5,05	27,70	7,36	31,93	7,09	0,294
04.637	3,960	5,05	30,62	10,2	27,45	7,71	0,294
05.637	4,500	5,72	35,42	10,6	39,45	8,02	0,333
81.010	2,700	3,43	14,53	5,38	13,05	5,10	0,202
400.051	4,300	5,44	76,01	15,2	34,64	11,55	0,316
400.052	2,630	3,34	8,98	4,49	16,86	5,62	0,197
400.054	2,900	3,69	14,97	5,98	19,83	6,61	0,217
400.055	2,210	2,82	3,08	2,47	12,41	4,13	0,167

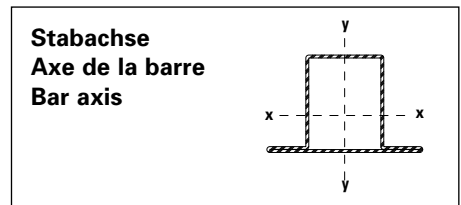

Artikelbibliothek
 Bibliothèque des articles
 Article library

DXF **DWG**

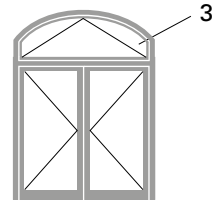
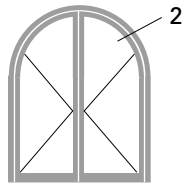
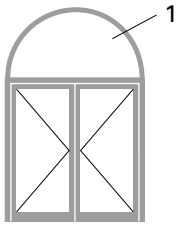

1.0

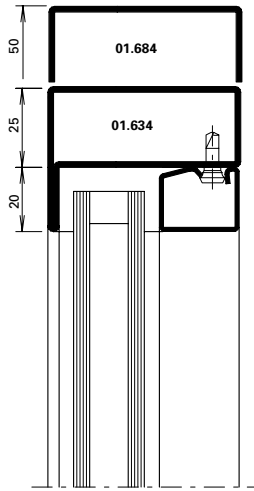

2.0

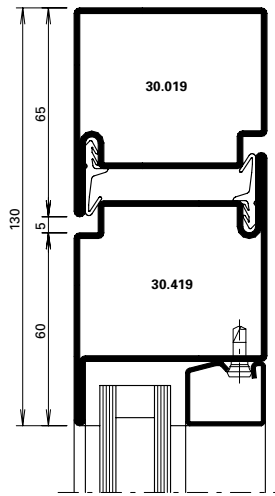

3.0

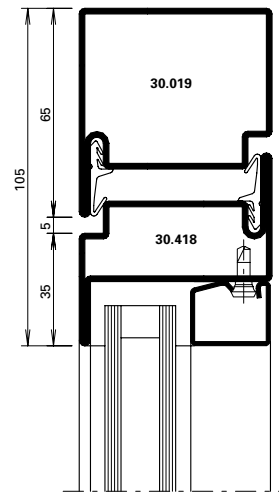

Halbrundbogen
 Arc semi-circulaire
 Semi-circular arch

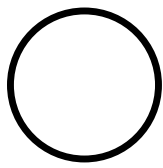

Rundbogen
 Arc en plein centre
 Round arch

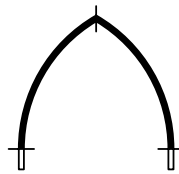

Spitzbogen
 Ogive
 Gothic arch



Stichbogen
 Arc bombé
 Segmented arch



Korbbogen
 Anse de panier
 Oval arch

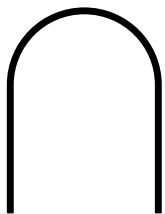

Halbrundbogen mit Schenkel
 Arc surhaussé
 Semi-circular arch with side extension

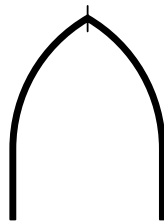

Spitzbogen mit Schenkel
 Arc en ogive
 Gothic arch with side extension

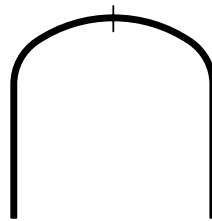



Korbbogen mit Schenkel
 Anse de panier prolongée
 Oval arch with side extension

Bogentüren
Portes cintrées
Arched doors

Jansen-Economy 60 Türen
 Jansen-Economy 60 portes
 Jansen-Economy 60 doors

Profil Profilé Profile	Min. Radius Rayon min. Min. radius R	
------------------------------	---	--

	blank brut bright	verzinkt zinguée galvanised
	mm	mm
01.634	350	
01.684	450	900

	blank brut bright	verzinkt zinguée galvanised
	mm	mm
02.634	350	600
02.684		1050

	blank brut bright	verzinkt zinguée galvanised
		mm
04.637		1550

	blank brut bright	verzinkt zinguée galvanised
		mm
05.637		1550

	blank brut bright	verzinkt zinguée galvanised
	mm	mm
400.052	800	1100
400.054		1000
400.055		700
81.010	1100	1100

Profil Profilé Profile	Min. Radius Rayon min. Min. radius R	
------------------------------	---	--

	blank brut bright	verzinkt zinguée galvanised
	mm	mm
30.018		500
30.019		650

	blank brut bright	verzinkt zinguée galvanised
		mm
30.118		800
30.119		900

	blank brut bright	verzinkt zinguée galvanised
		mm
30.418		800
30.419		1100

Stahl-Glasleisten Parcloses en acier Steel glazing beads	Min. Radius Rayon min. Min. radius R
--	---

	mm
62.507 Z	300 mm
62.508 Z	300 mm
62.509 Z	300 mm

Stahl-Glasleisten Parcloses en acier Steel glazing beads	Min. Radius Rayon min. Min. radius R
--	---

	mm
402.112 Z	500 mm
402.115 Z	500 mm
402.120 Z	600 mm
402.125 Z	750 mm
402.130 Z	1000 mm
402.135 Z	1500 mm

Aluminium-Glasleisten Parcloses en aluminium Aluminium glazing beads	Min. Radius Rayon min. Min. radius R
--	---

	mm
404.109	400 mm
404.112	400 mm
404.115	400 mm
404.120	400 mm
404.125	450 mm
404.130	500 mm
404.135	600 mm

	mm
405.110	500 mm
405.115	500 mm
405.120	500 mm
405.125	800 mm
405.130	1000 mm
405.135	1000 mm
406.903	500 mm
406.905	500 mm
406.907	500 mm
406.909	600 mm

Die Radien-Angaben beziehen sich auf die langjährige Erfahrung und Fertigung im Hause Jansen.

Les rayons indiqués se fondent sur la longue expérience et la fabrication au sein de la maison Jansen.

The radii specifications are based on the many years of experience Jansen has in fabrication.

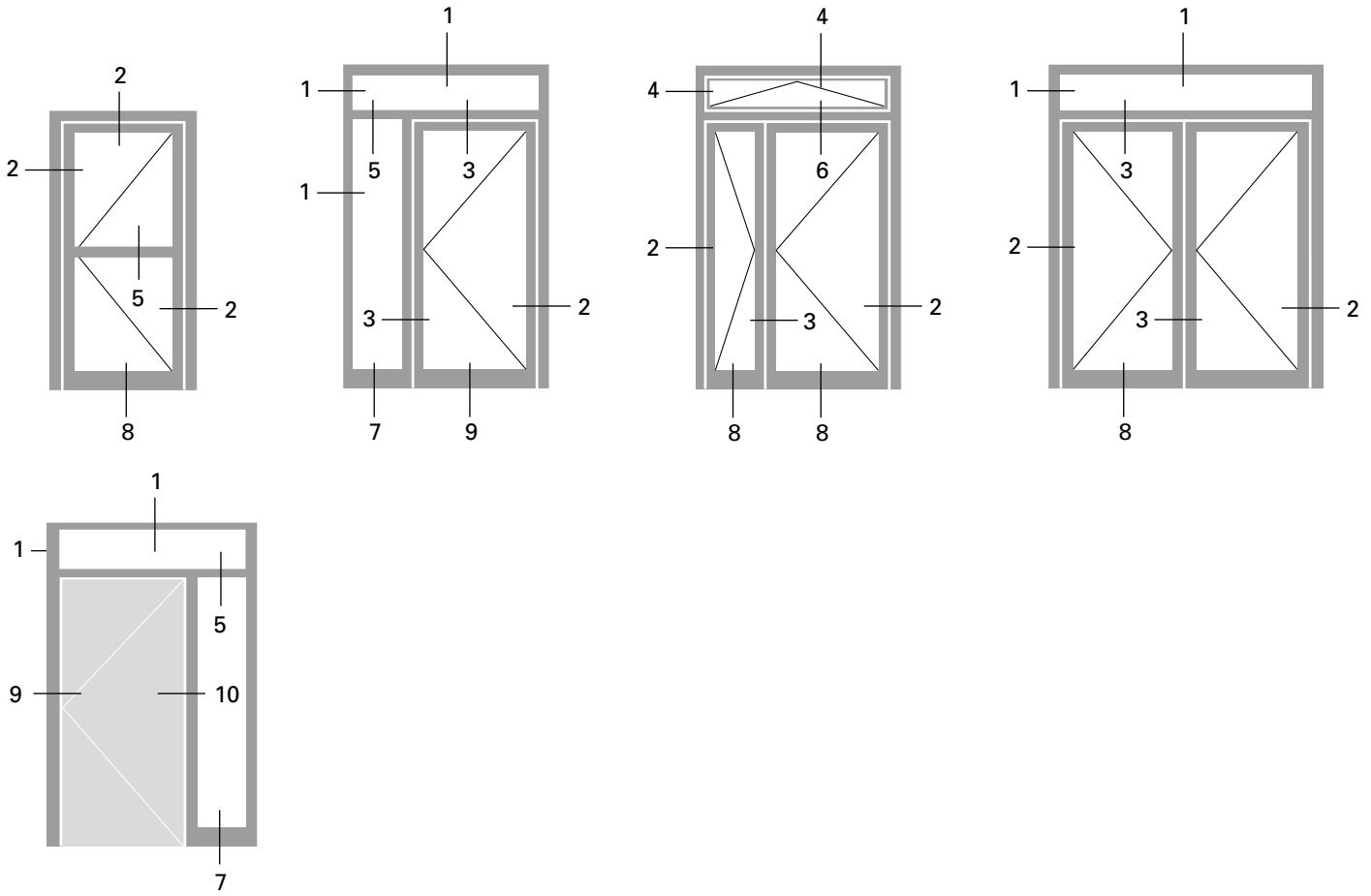

1.0

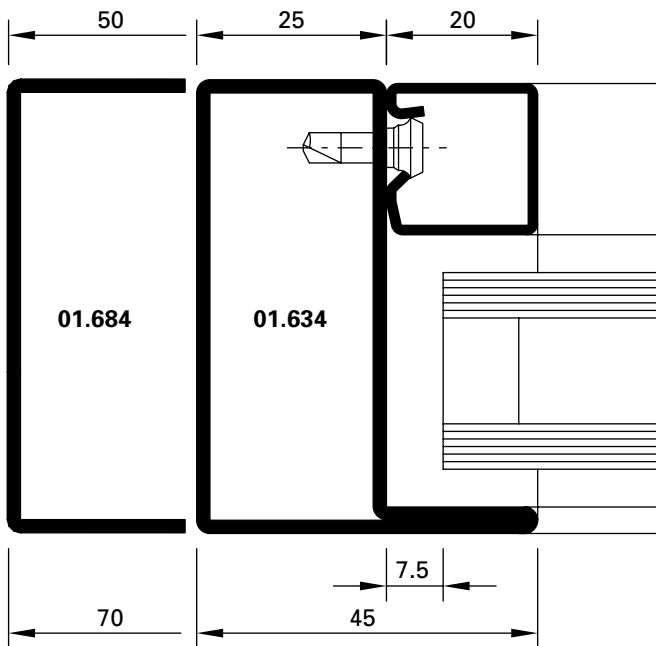

5.1

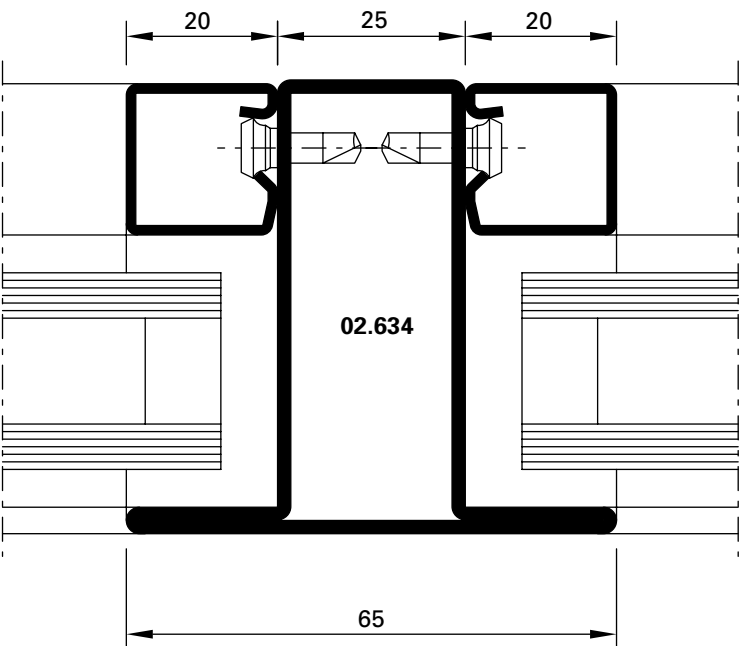

DXF DWG D-250-C-001

DXF DWG D-250-C-032

2.0

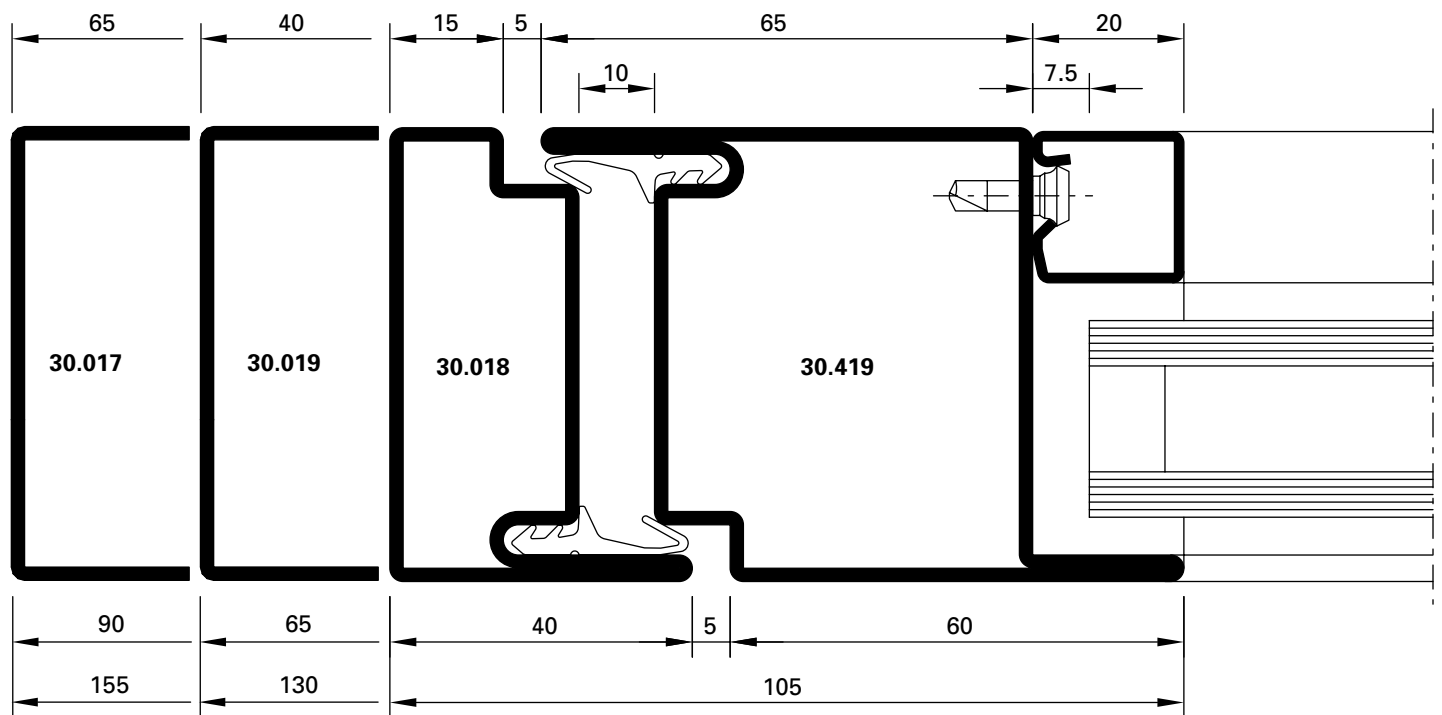

DXF **DWG** D-250-C-002

2.2

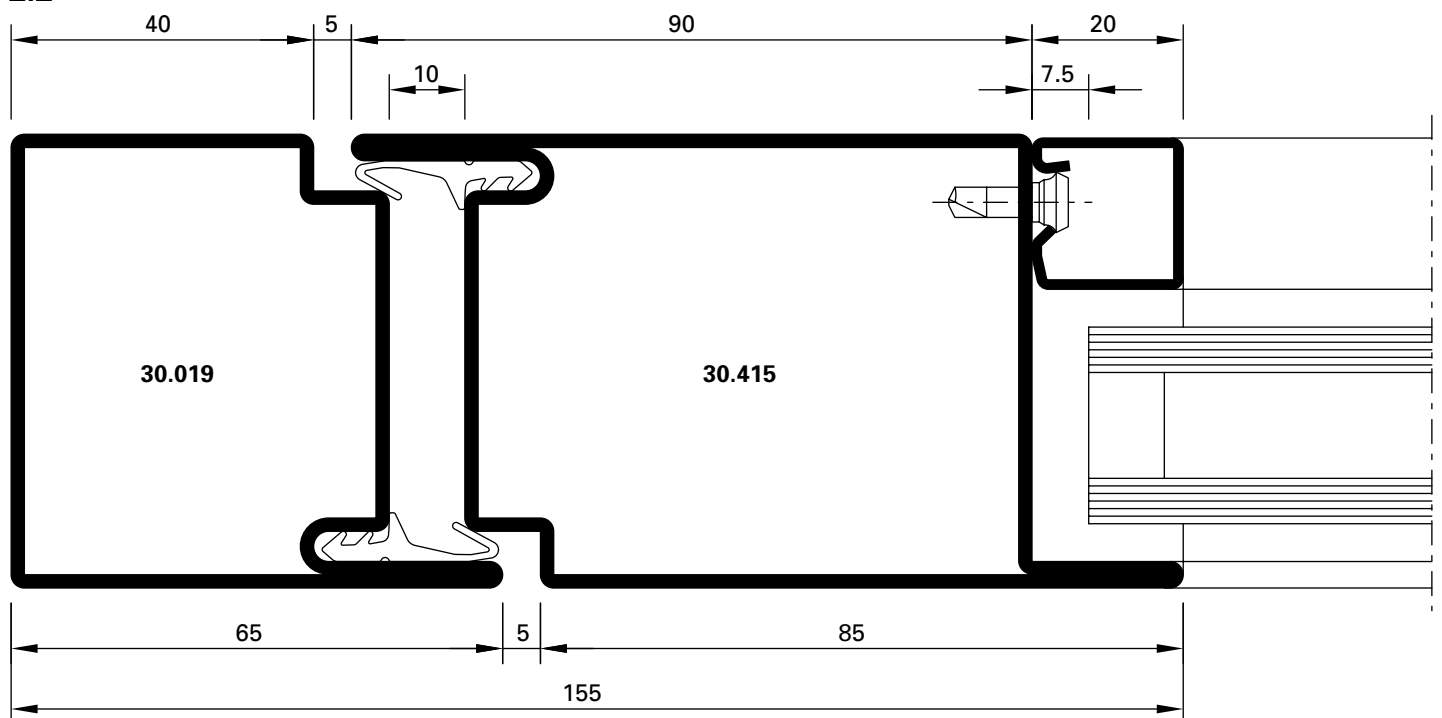

DXF **DWG** D-250-C-005

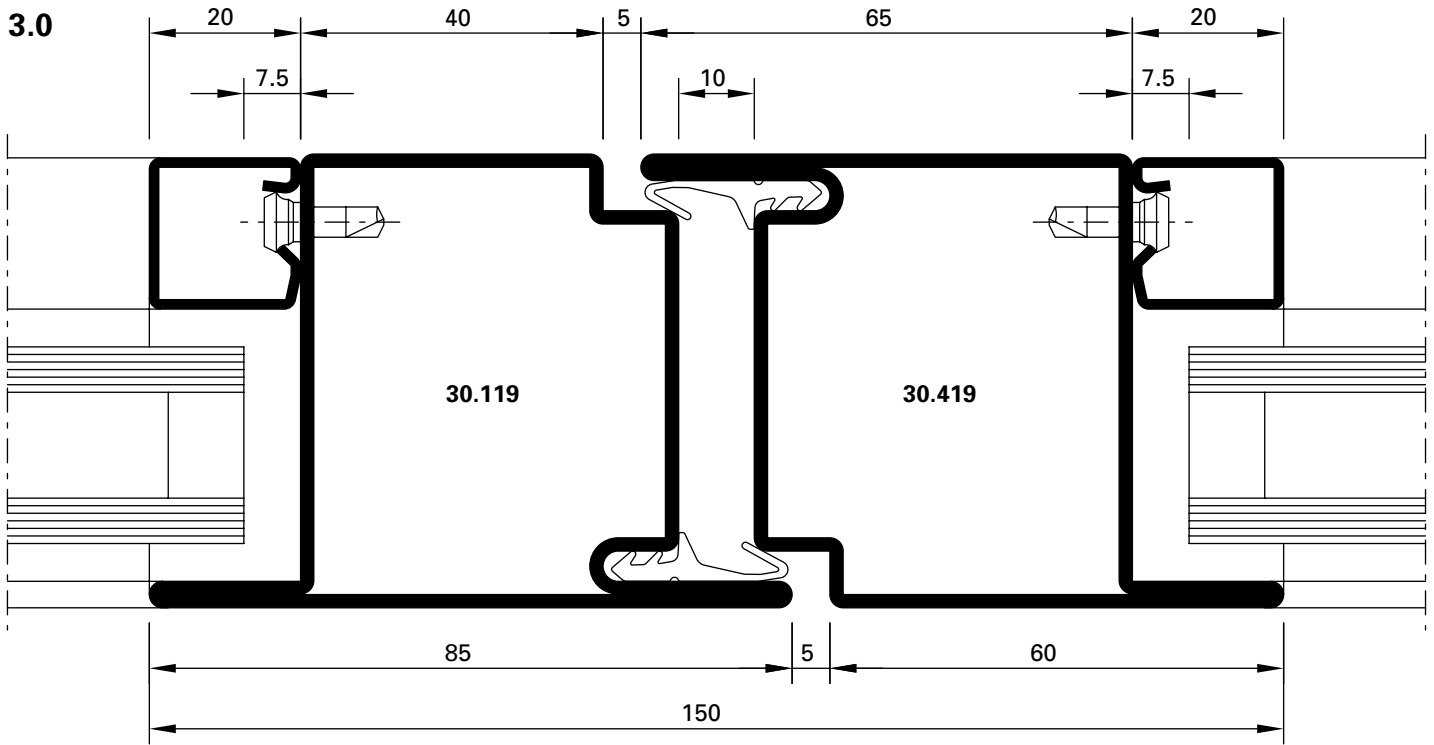

DXF DWG D-250-C-003

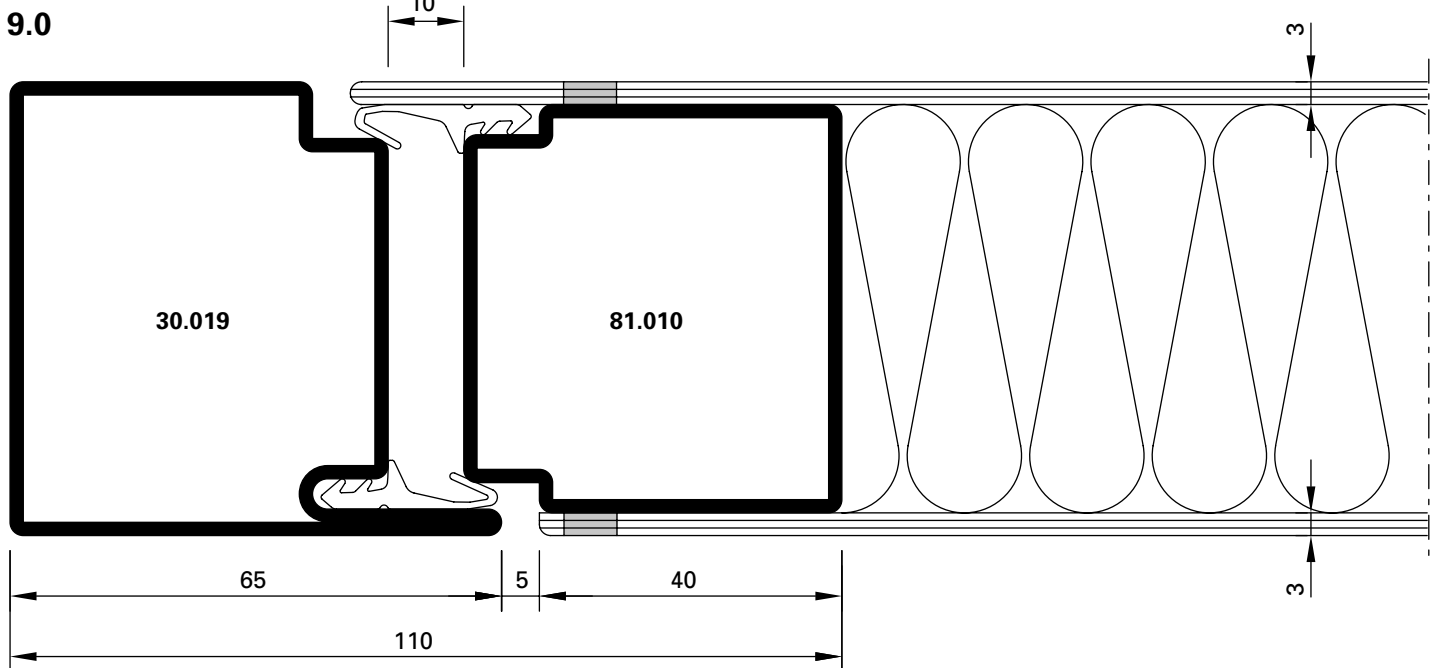

DXF DWG D-250-C-013

4.0

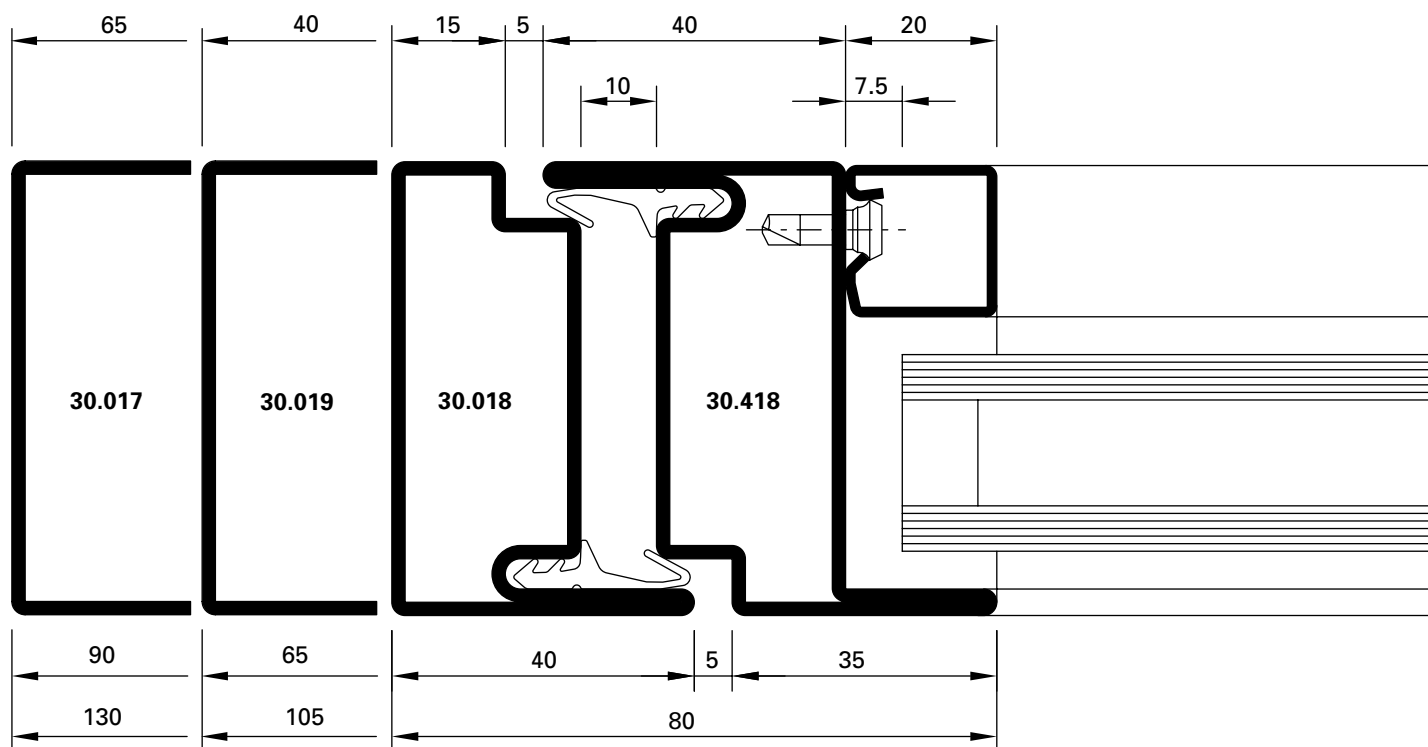

DXF **DWG** D-250-C-010

5.0

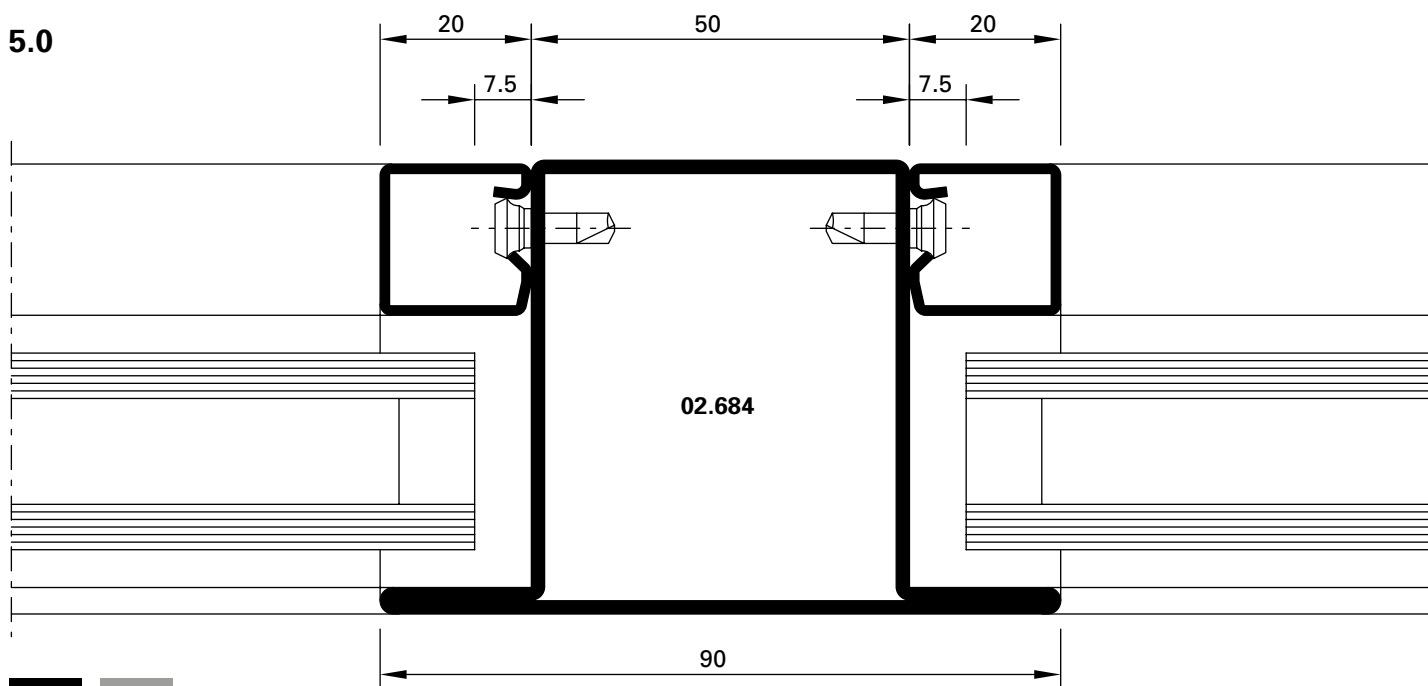

DXF **DWG** D-250-C-012

8.0

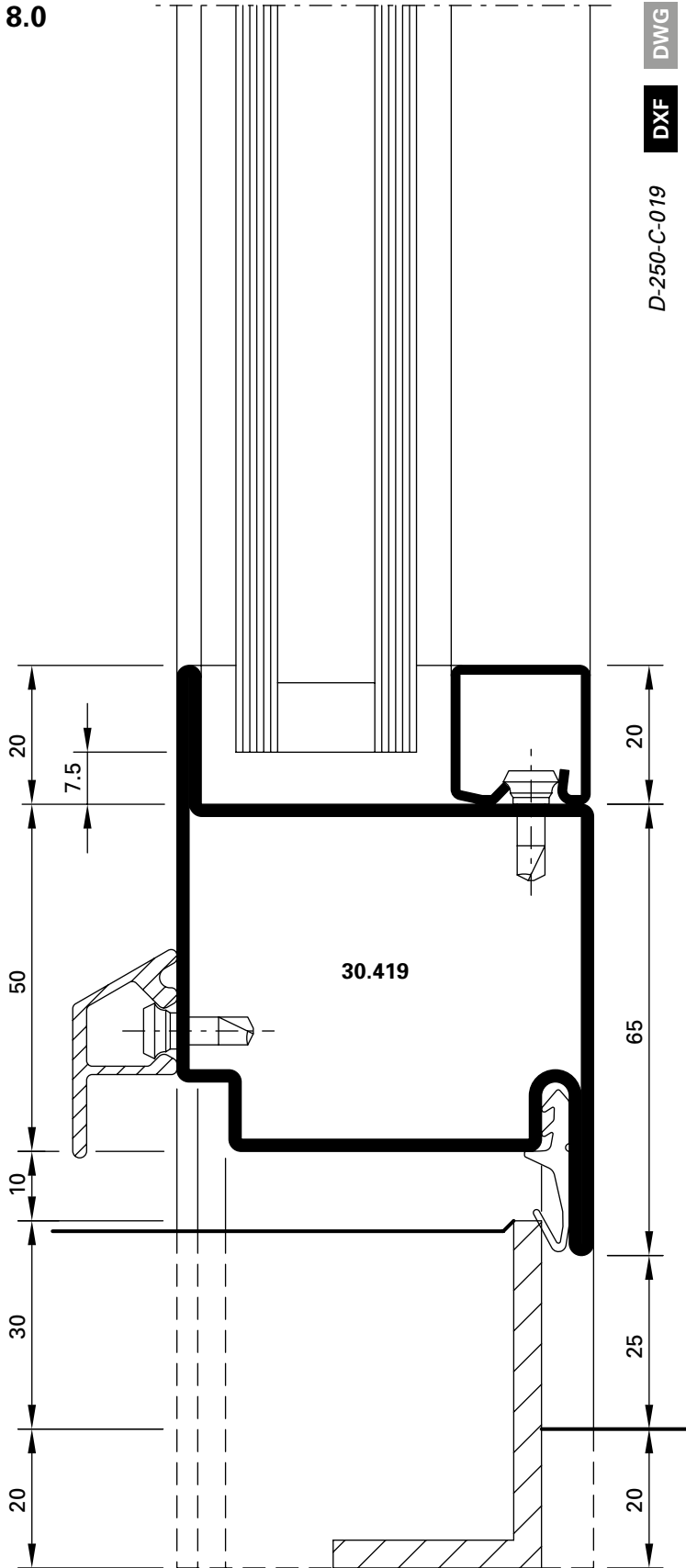

8.1

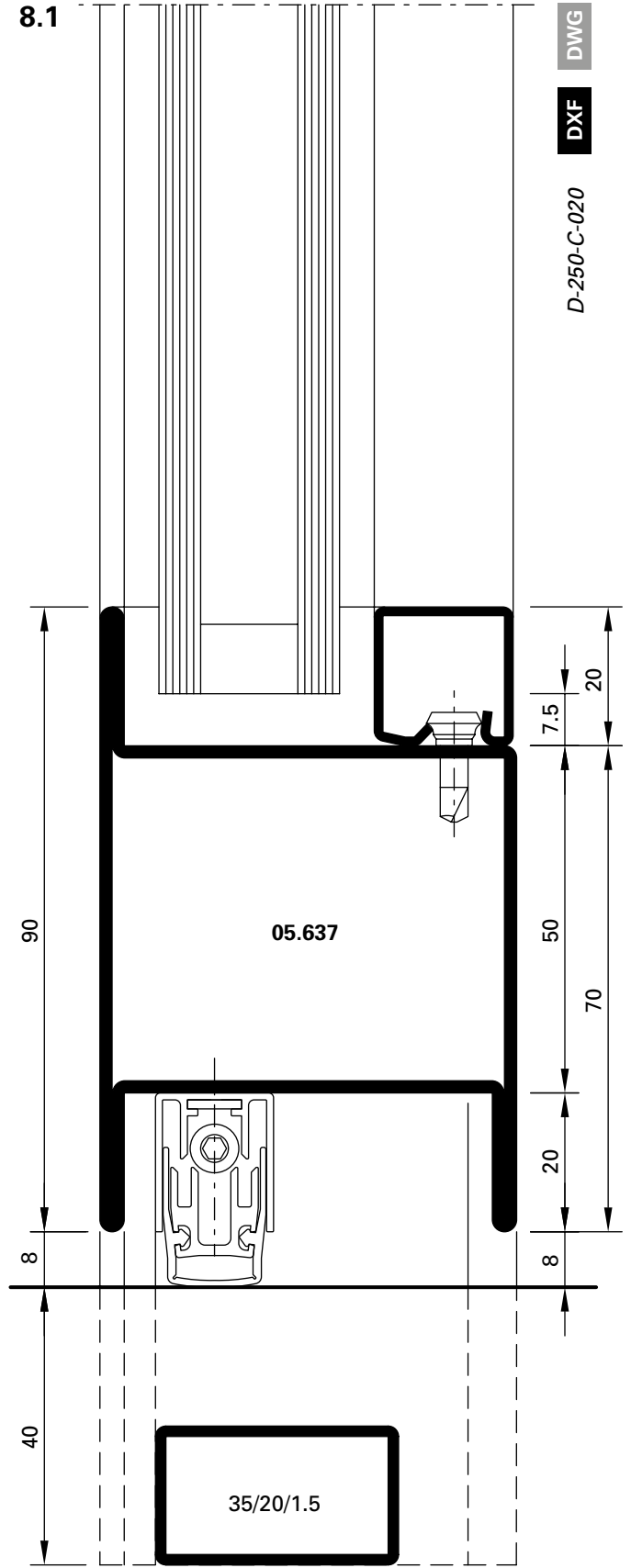

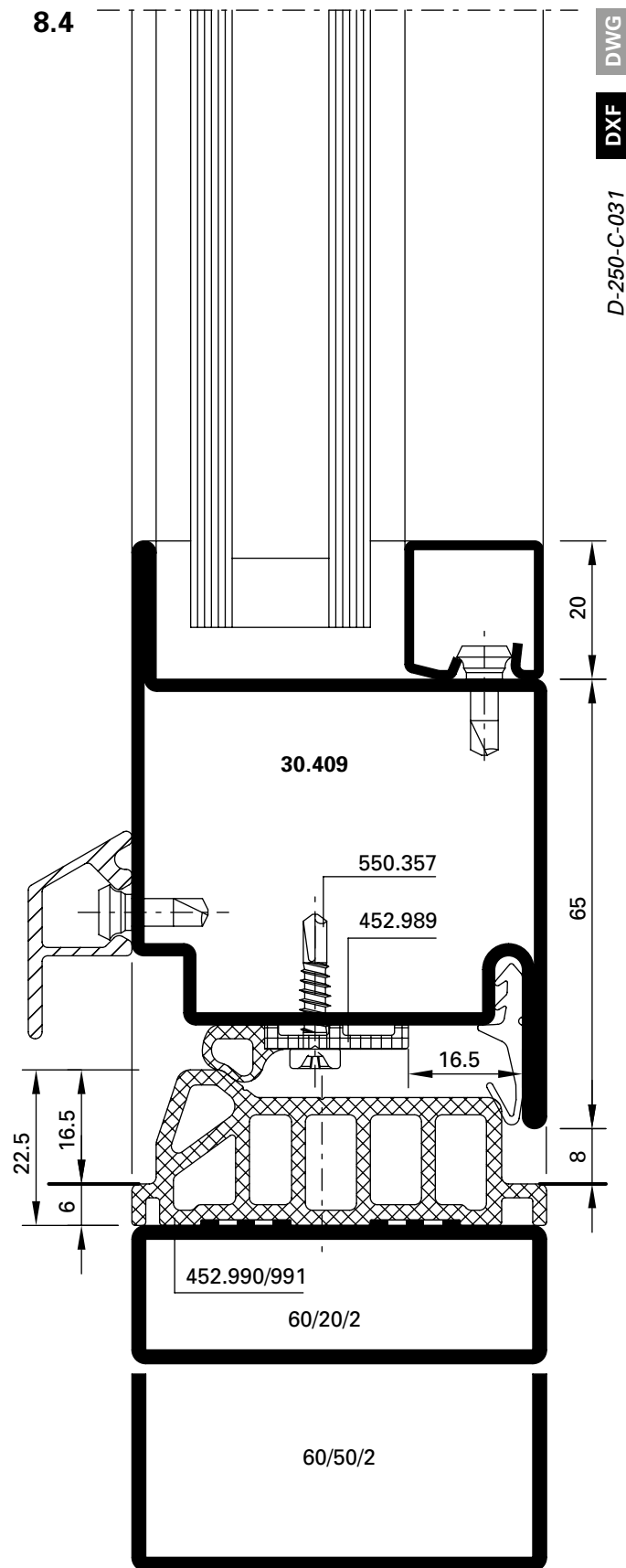
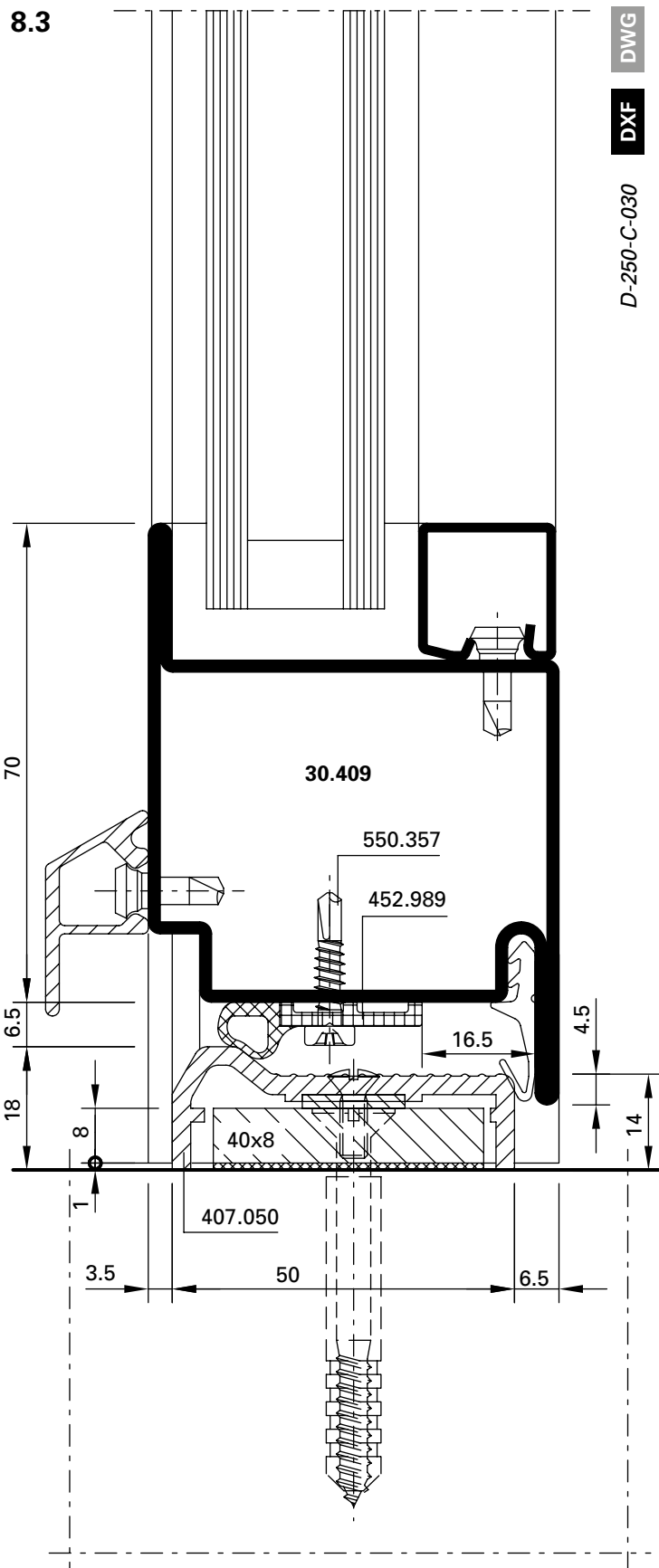

2.1

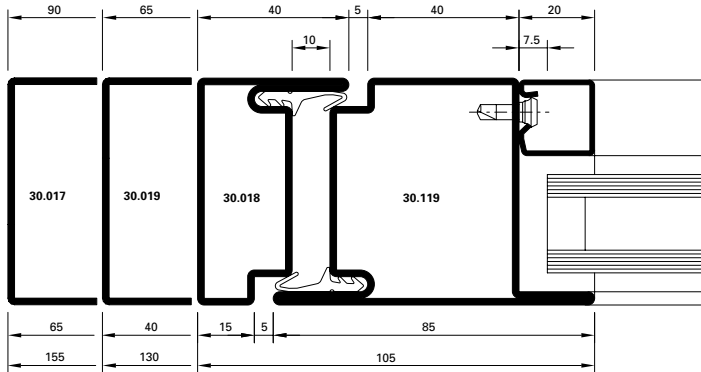

DXF **DWG** *D-250-C-004*

2.3

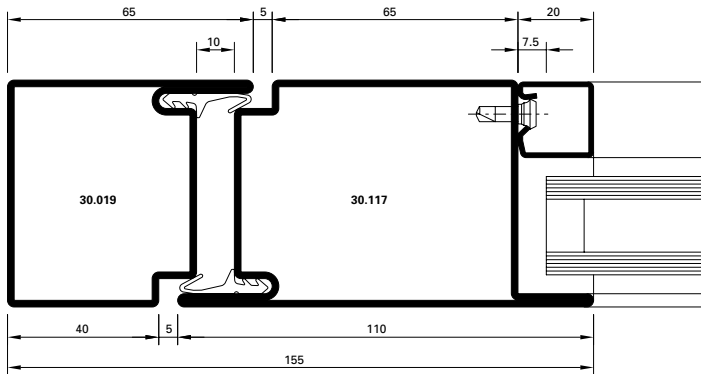

DXF **DWG** *D-250-C-006*

3.1

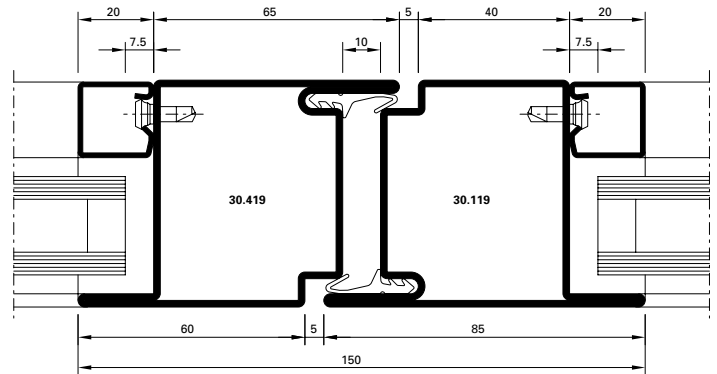

DXF **DWG** *D-250-C-007*

3.2

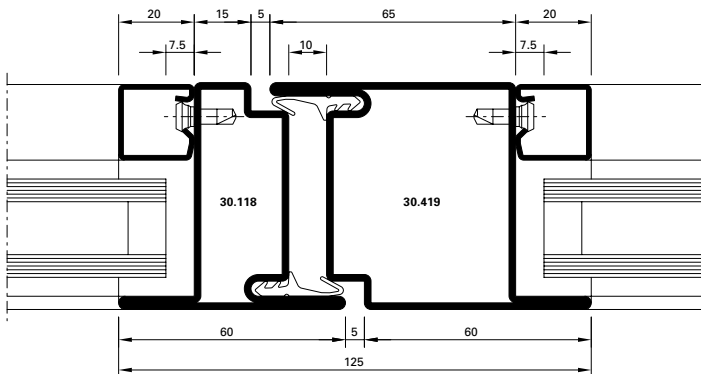

DXF **DWG** *D-250-C-008*

3.3

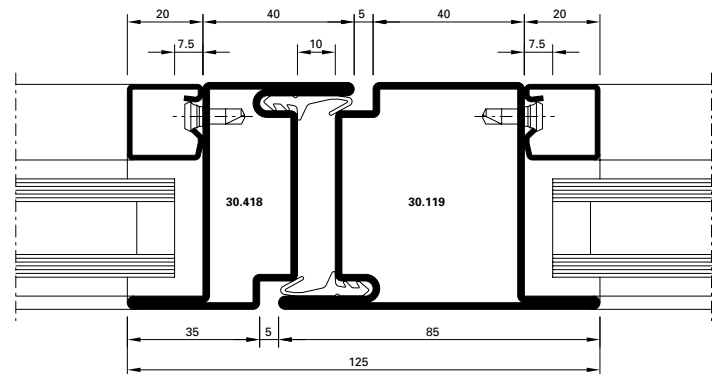

DXF **DWG** *D-250-C-009*

9.1

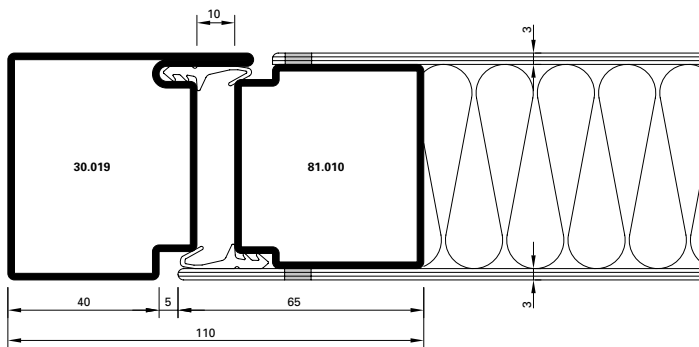

DXF **DWG** D-250-C-014

10.0

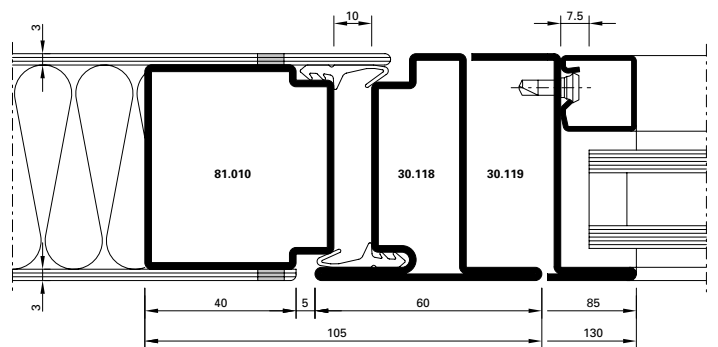

DXF **DWG** D-250-C-015

5.1

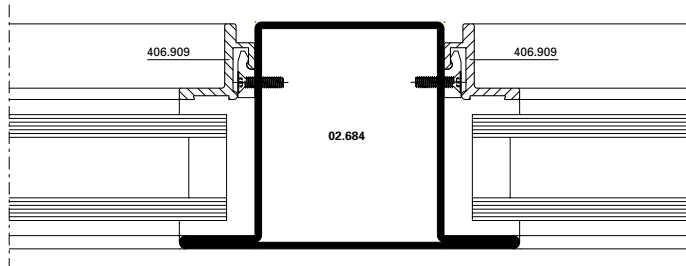

DXF **DWG** *D-250-C-022*

5.2

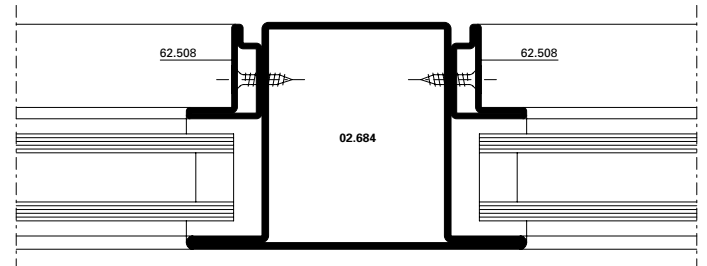

DXF **DWG** *D-250-C-023*

5.3

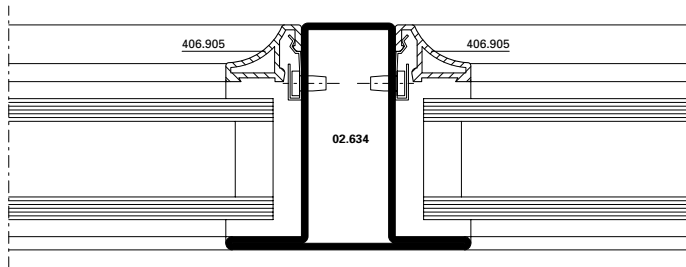

DXF **DWG** *D-250-C-024*

5.4

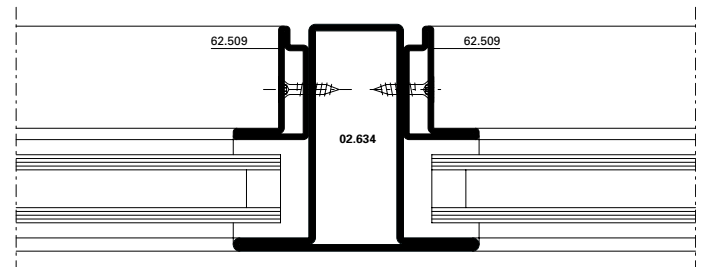

DXF **DWG** *D-250-C-025*

5.5

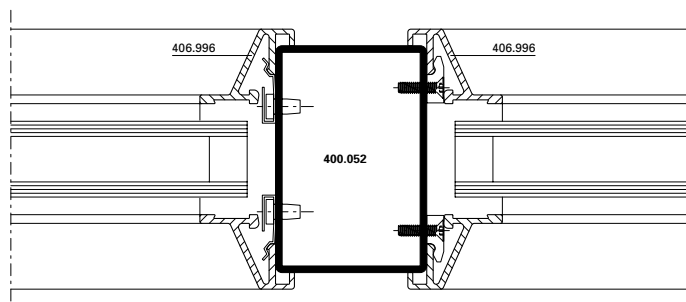

DXF **DWG** *D-250-C-026*

5.6

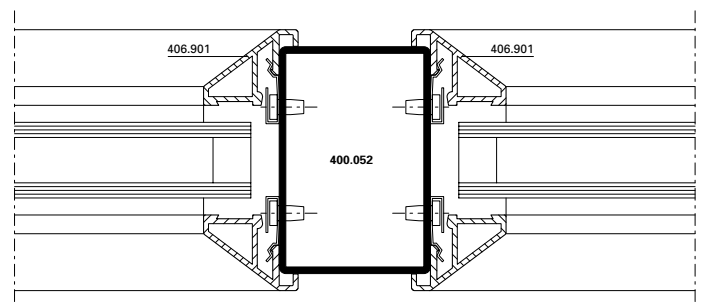

DXF **DWG** *D-250-C-027*

5.7

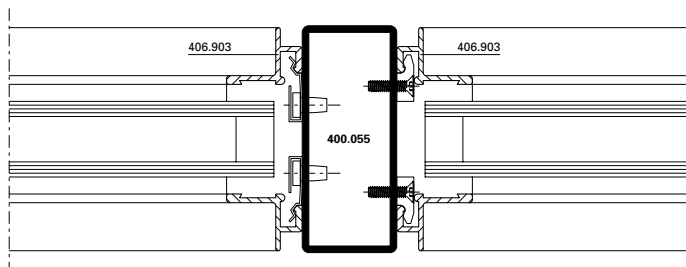

DXF **DWG** *D-250-C-028*

5.8

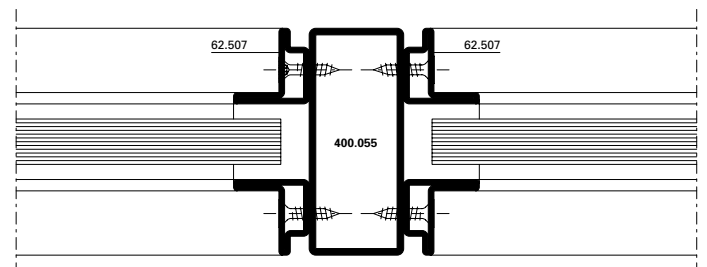

DXF **DWG** *D-250-C-029*

Schnittpunkte im Massstab 1:1
Coupe de détails à l'échelle 1:1
Section details on scale 1:1

Jansen-Economy 60 Türen
Jansen-Economy 60 portes
Jansen-Economy 60 doors

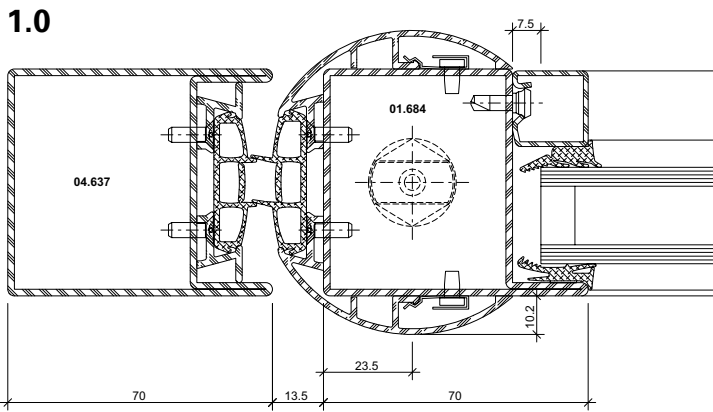
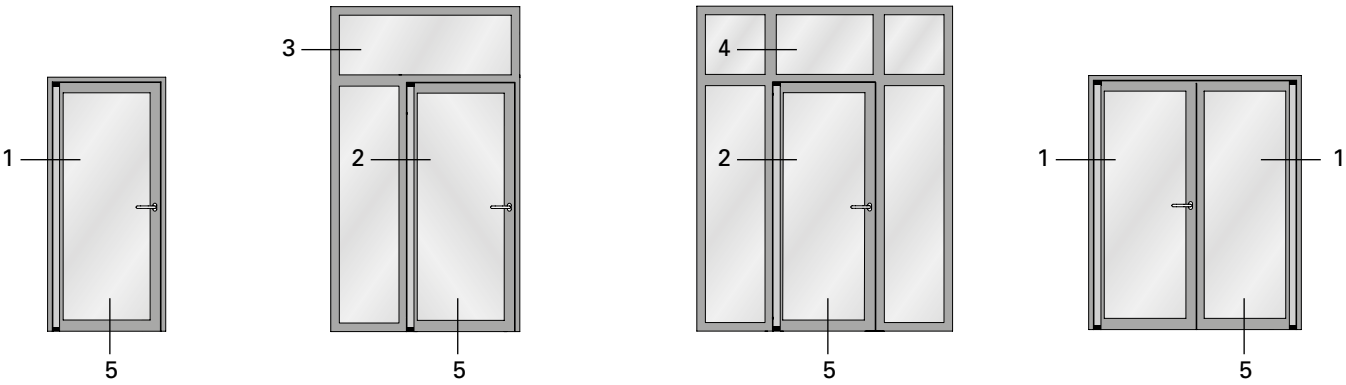

DXF **DWG** 22-0103-C-001

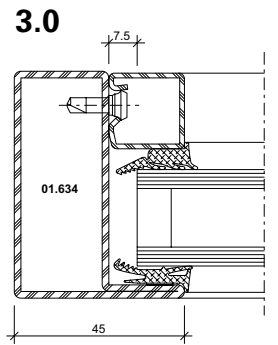

22-0101-C-001

DXF **DWG**

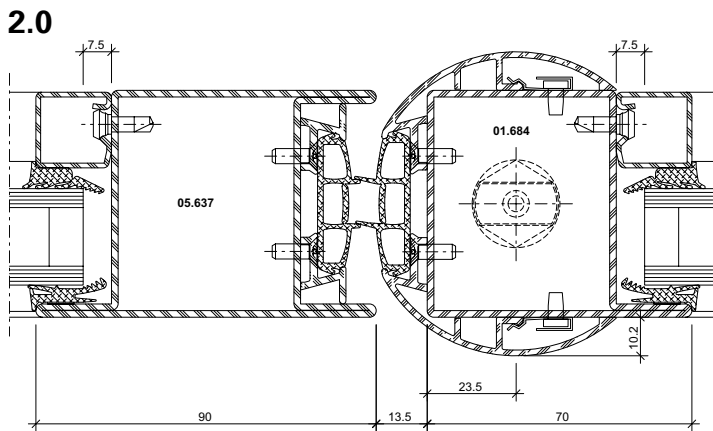

DXF **DWG** 22-0103-C-002

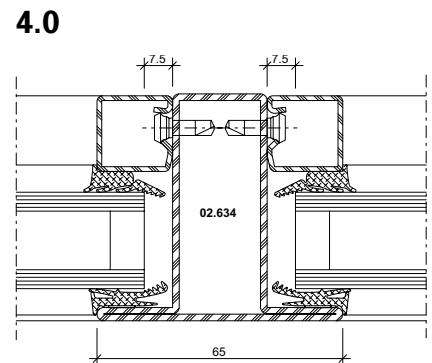

22-0101-C-002

DXF **DWG**

5.0

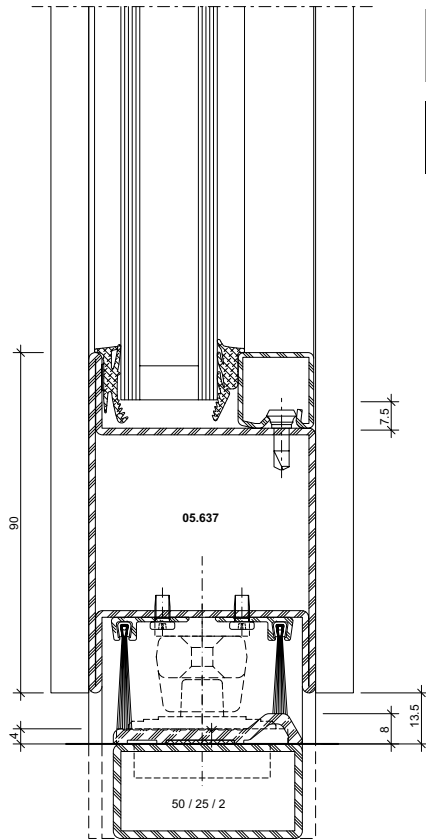

DWG

DXF

22-0103-C-003

5.1

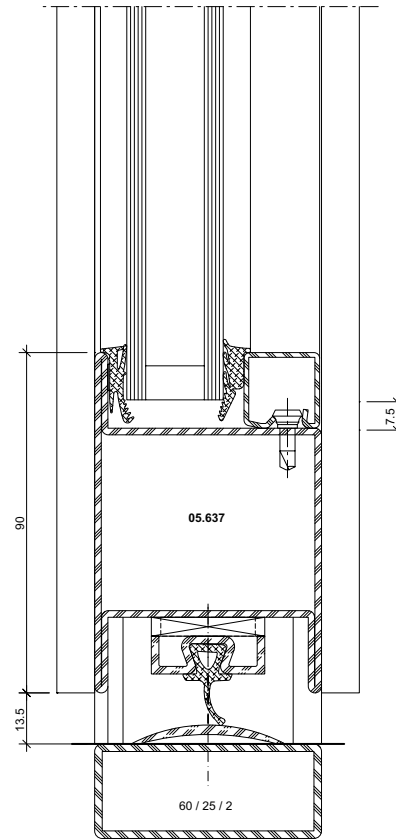

DWG

DXF

22-0103-C-009

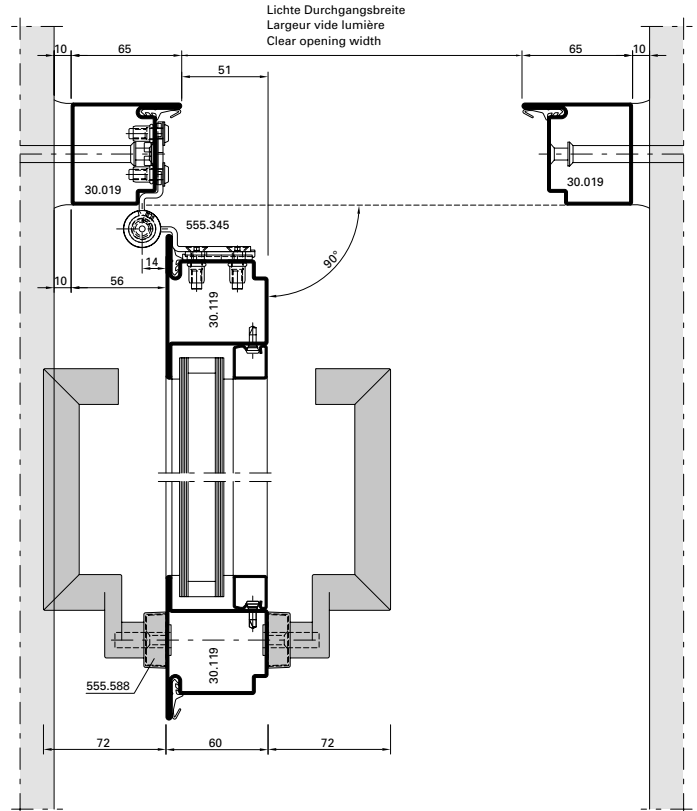
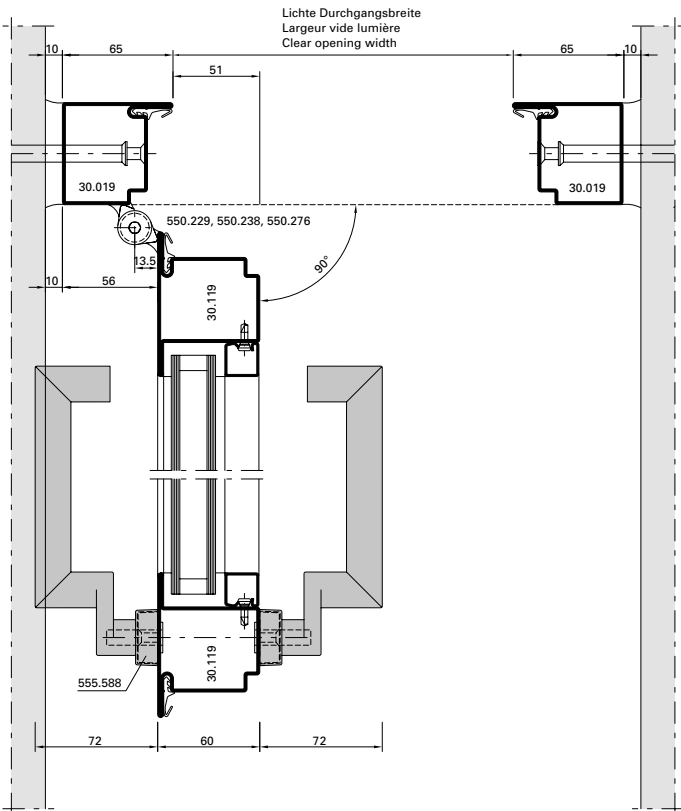

DXF **DWG** *D-250-E-016*

DXF **DWG** *D-250-E-018*

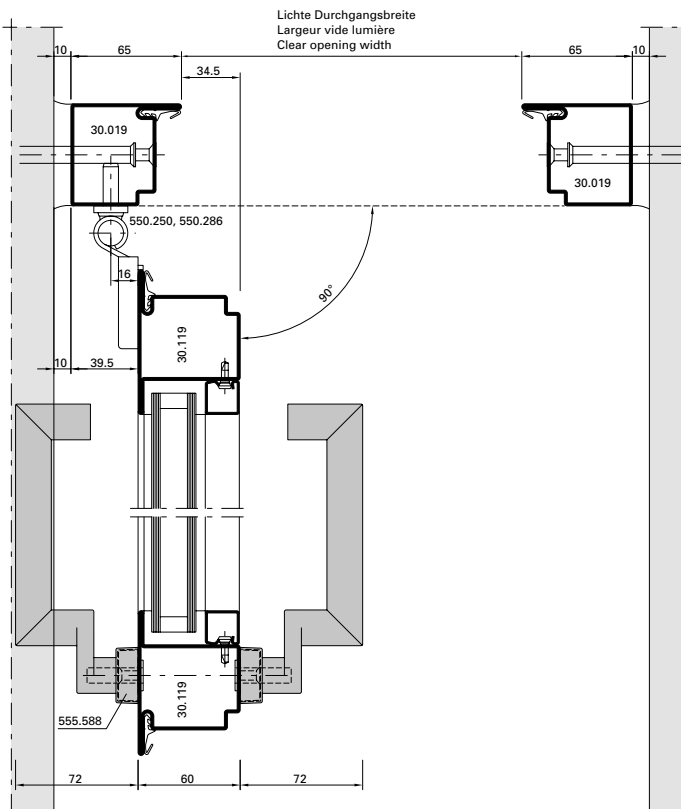

DXF **DWG** *D-250-E-020*

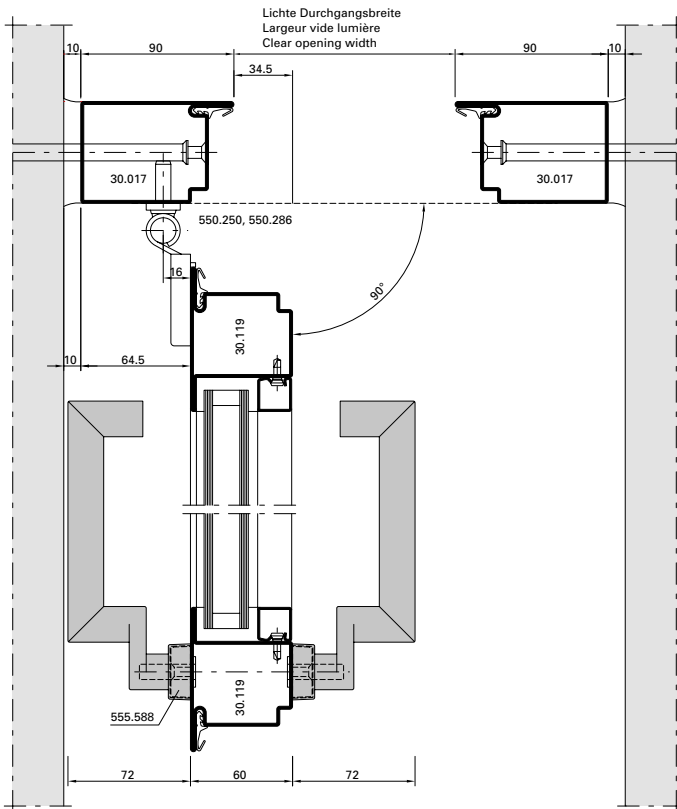

DXF DWG D-250-E-021

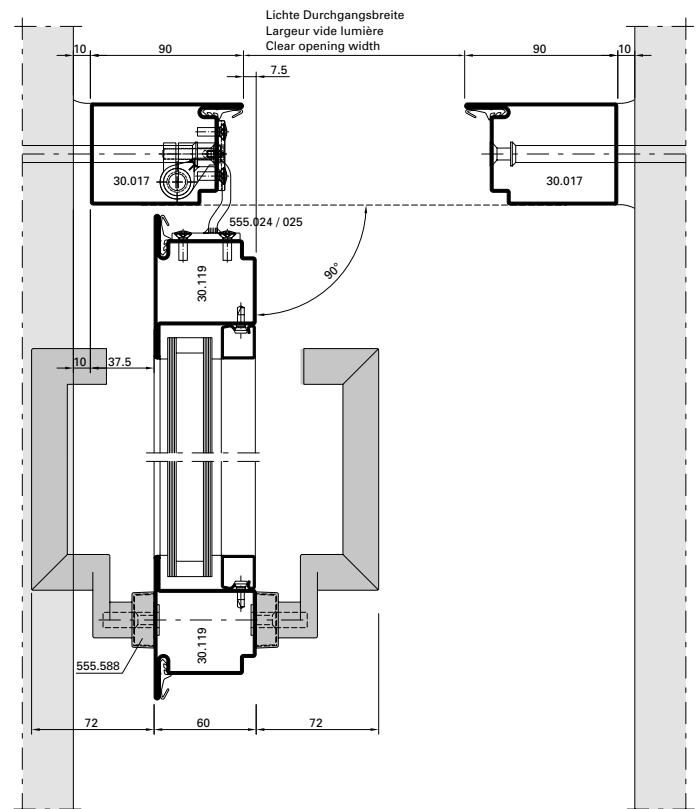

DXF DWG D-250-E-025

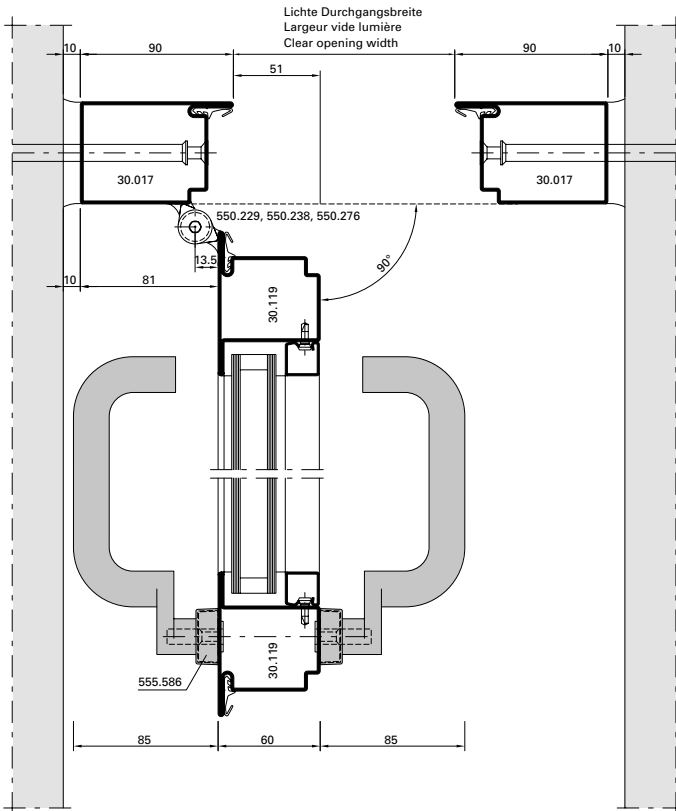

DXF **DWG** *D-250-E-017*

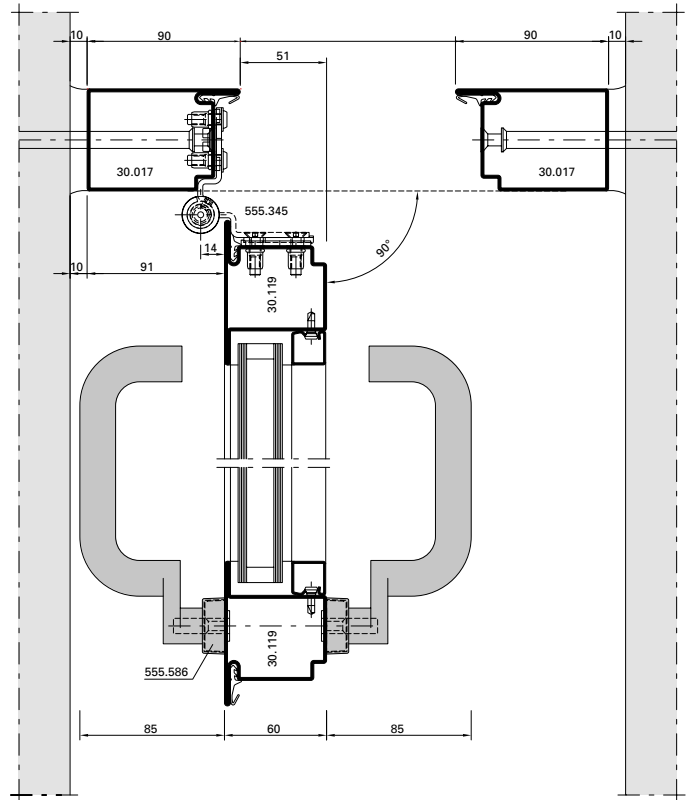

DXF **DWG** *D-250-E-019*

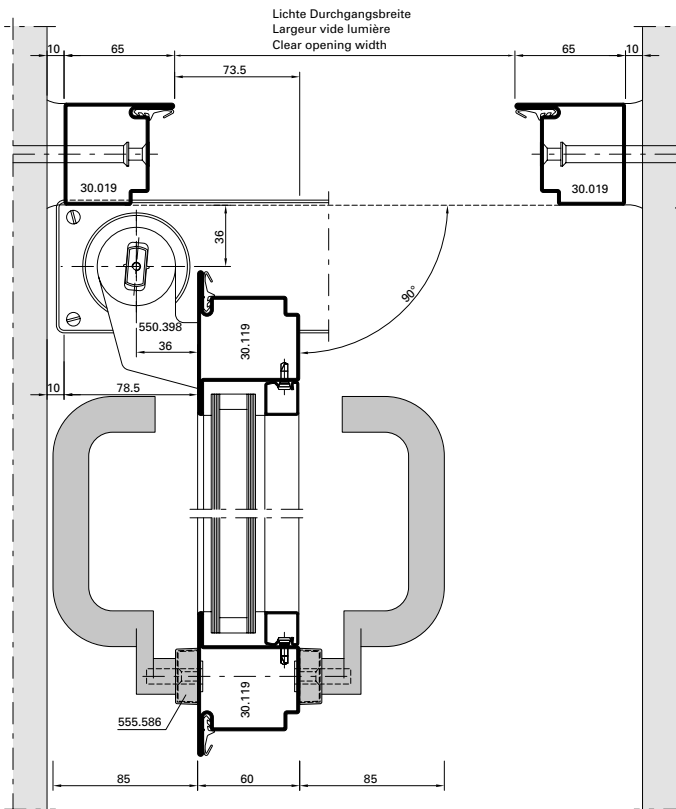

DXF **DWG** *D-250-E-022*

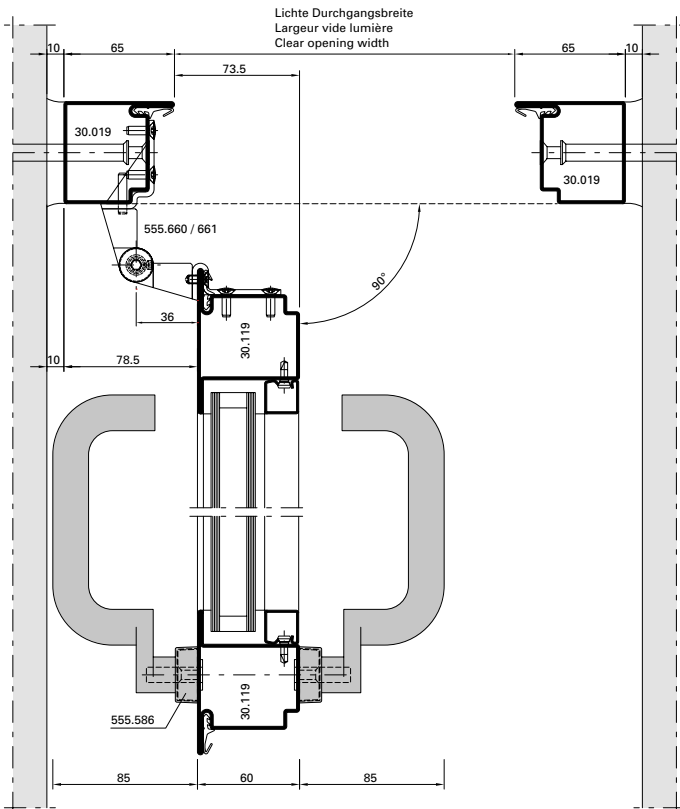

DXF **DWG** *D-250-E-023*

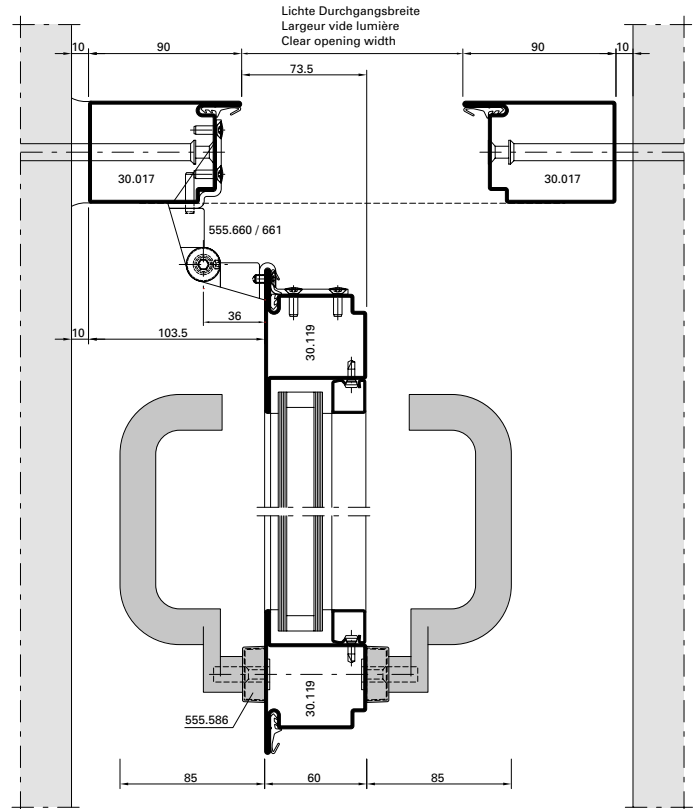

DXF **DWG** *D-250-E-024*

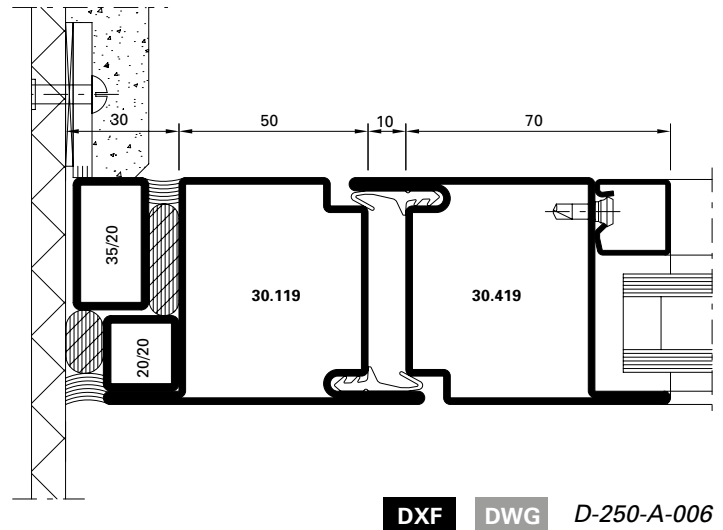
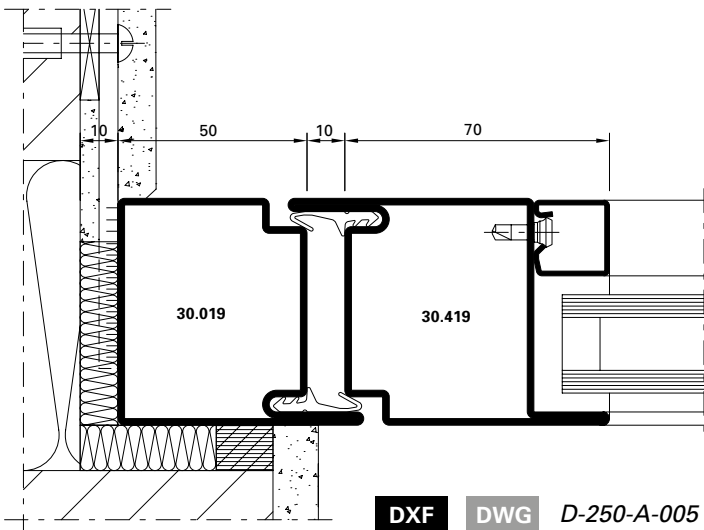
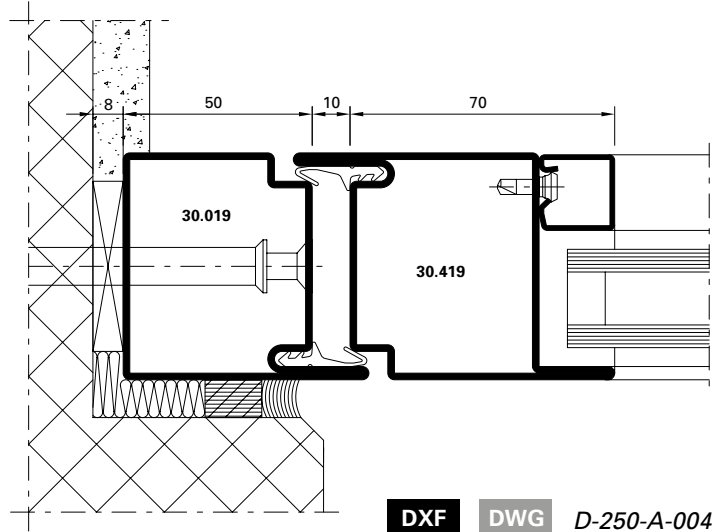
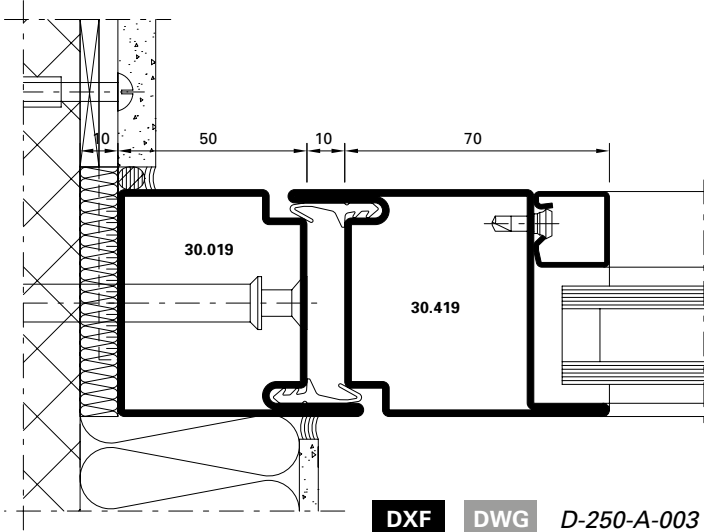
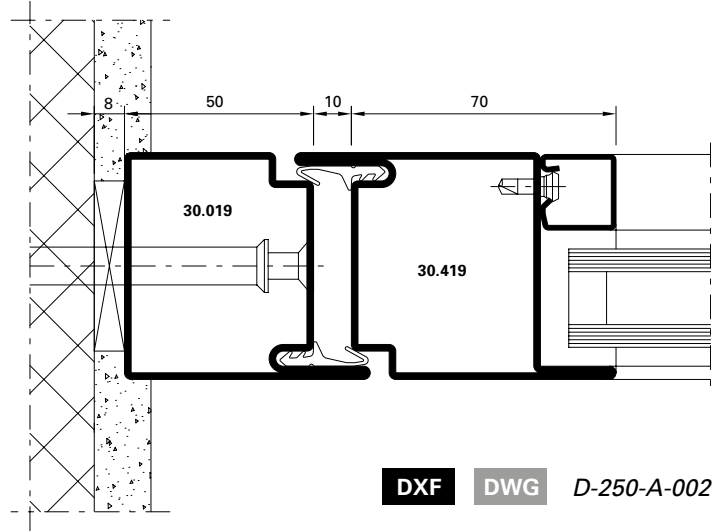
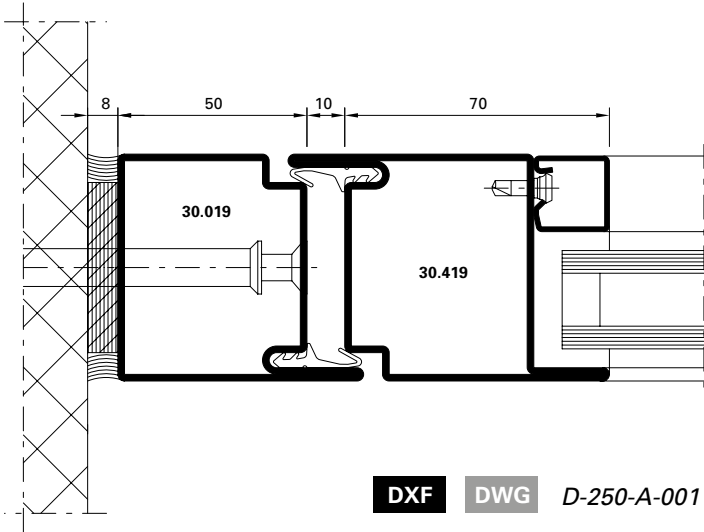

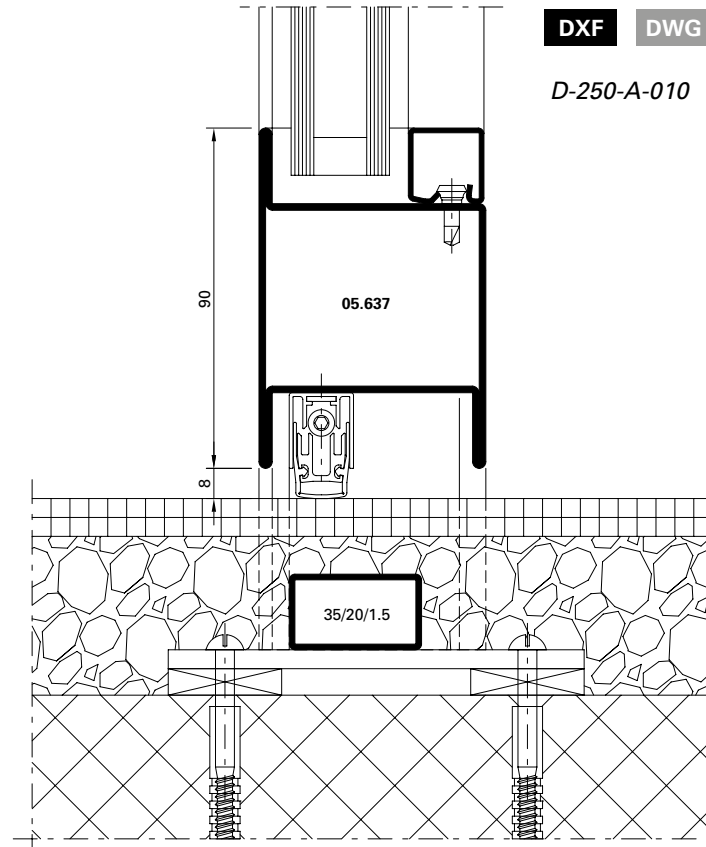
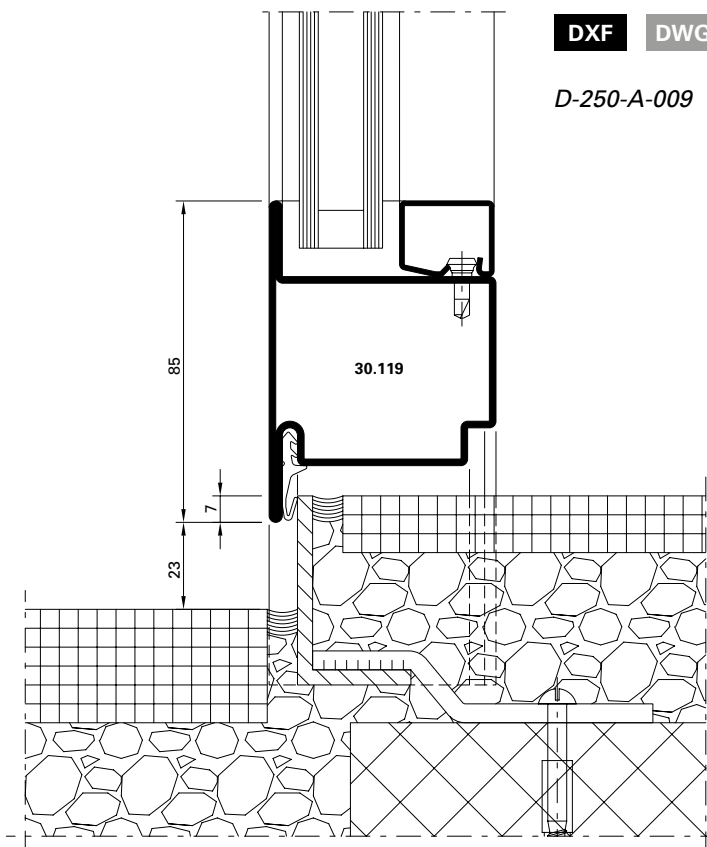
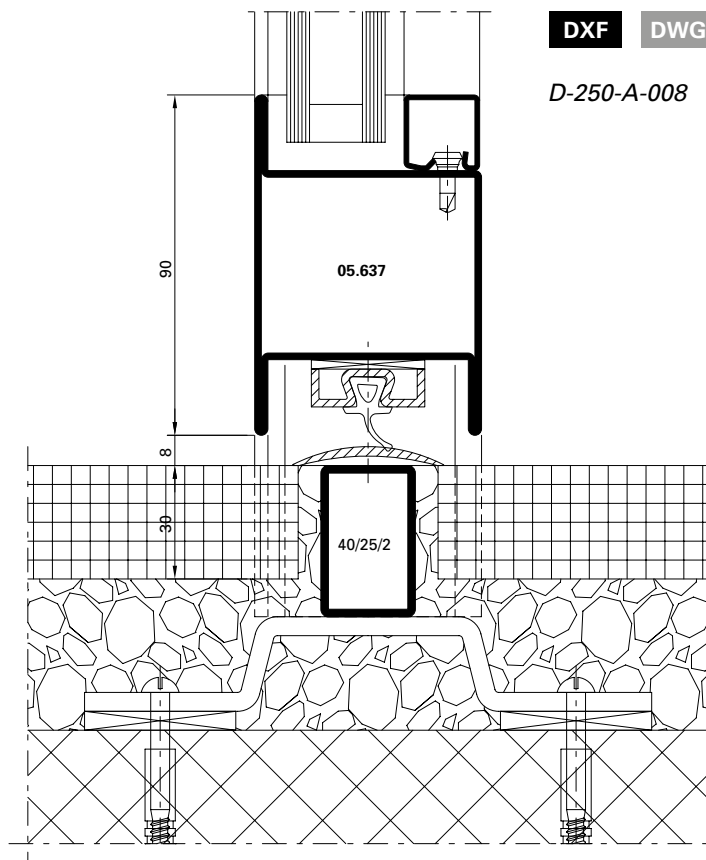
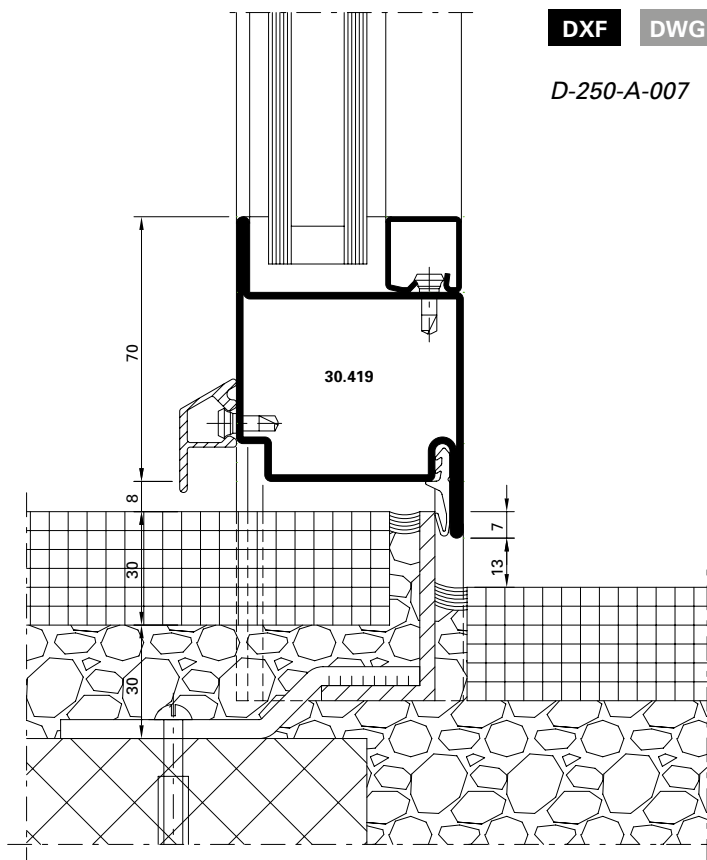



Einflügelige Türen,
 auswärts öffnend,
 Flügelhöhe ≤ 2200 mm

Porte à un vantail,
 ouvrant vers l'extérieur,
 hauteur du vantail ≤ 2200 mm

Single leaf door,
 outward opening,
 leaf height ≤ 2200 mm

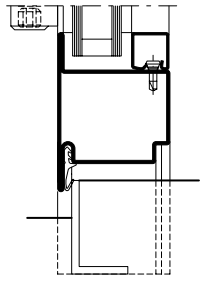
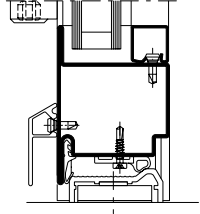
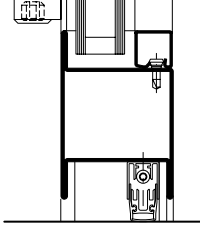
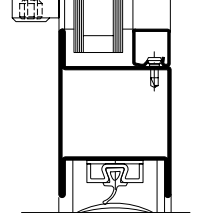
Variante	Beschlag Ferrure Fitting	 EN 12207	 EN 12208	 EN 12210	
Anschlagdichtung Joint de butée Rebate gasket		1	2	1A	C4
		2	2	2A	C4
		3	3	2A	C5
Doppel-Anschlagdichtung Joint de base double Double rebate gasket		1	4	3A	C4
		2	4	3A	C4
		3	4	5A	C5
Senkdichtung Joint seuil Drop seal		1	2	1A	C4
		2	2	2A	C4
		3	3	2A	C5
Auflaufdichtung Joint de contact Ramp seal		1	2	0	C4
		2	2	0	C4
		3	2	0	C5

1 Fallenriegel-Schloss
 Serrure à mortaiser
 Latch and bolt lock





2 Schloss mit Obenverriegelung
 Serrure avec verrouillage supérieur
 Lock with top locking point

3 Mehrfachverriegelungs-Schloss
 Serrure à verrouillage multiple
 Multipoint lock

Einflügelige Türen,
 einwärts öffnend,
 Flügelhöhe ≤ 2200 mm

Porte à un vantail,
 ouvrant vers l'intérieur,
 hauteur du vantail ≤ 2200 mm

Single leaf door,
 inward opening,
 leaf height ≤ 2200 mm

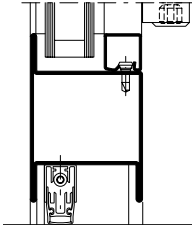
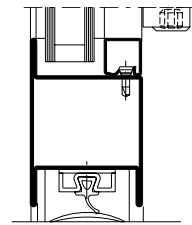
Variante		Beschlag Ferrure Fitting	 EN 12207	 EN 12208	 EN 12210
Senkdichtung Joint seuil Drop seal		❶	2	0	C4
		❷	2	0	C4
		❸	3	1A	C5
Auflaufdichtung Joint de contact Ramp seal		❶	2	0	C4
		❷	2	0	C4
		❸	2	0	C5

❶ Fallenriegel-Schloss
 Serrure à mortaiser
 Latch and bolt lock



❷ Schloss mit Obenverriegelung
 Serrure avec verrouillage supérieur
 Lock with top locking point

❸ Mehrfachverriegelungs-Schloss
 Serrure à verrouillage multiple
 Multipoint lock

Einflügelige Türen,
 auswärts öffnend,
 Flügelhöhe ≤ 3000 mm

Porte à un vantail,
 ouvrant vers l'extérieur,
 hauteur du vantail ≤ 3000 mm

Single leaf door,
 outward opening,
 leaf height ≤ 3000 mm

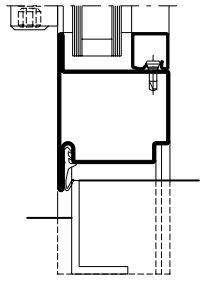
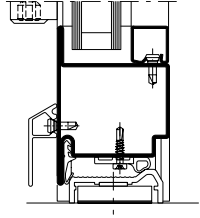
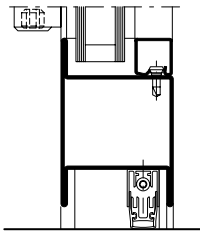
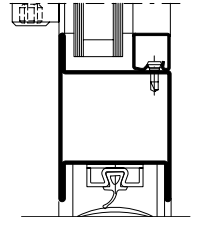
Variante	Beschlag Ferrure Fitting	 EN 12207	 EN 12208	 EN 12210
Anschlagdichtung Joint de butée Rebate gasket 	1	1	0	C1
	2	1	0	C1
	3	1	0	C2
Doppel-Anschlagdichtung Joint de base double Double rebate gasket 	1	1	1A	C1
	2	1	1A	C1
	3	2	2A	C2
Senkdichtung Joint seuil Drop seal 	1	1	0	C1
	2	1	0	C1
	3	1	0	C2
Aufbaudichtung Joint de contact Ramp seal 	1	0	0	C1
	2	0	0	C1
	3	1	0	C2

1 Fallenriegel-Schloss
 Serrure à mortaiser
 Latch and bolt lock





2 Schloss mit Obenverriegelung
 Serrure avec verrouillage supérieur
 Lock with top locking point

3 Mehrfachverriegelungs-Schloss
 Serrure à verrouillage multiple
 Multipoint lock

Einflügelige Türen,
 einwärts öffnend,
 Flügelhöhe ≤ 3000 mm

Porte à un vantail,
 ouvrant vers l'intérieur,
 hauteur du vantail ≤ 3000 mm

Single leaf door,
 inward opening,
 leaf height ≤ 3000 mm

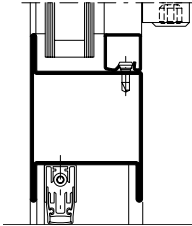
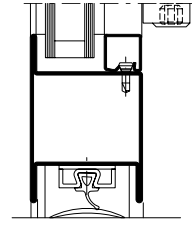
Variante		Beschlag Ferrure Fitting	 EN 12207	 EN 12208	 EN 12210
Senkdichtung Joint seuil Drop seal		❶	1	0	C1
		❷	1	0	C1
		❸	1	0	C2
Auflaufdichtung Joint de contact Ramp seal		❶	0	0	C1
		❷	0	0	C1
		❸	1	0	C2

❶ Fallenriegel-Schloss
 Serrure à mortaiser
 Latch and bolt lock













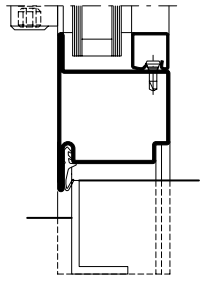



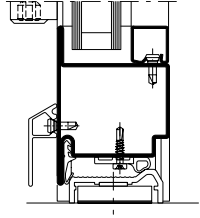



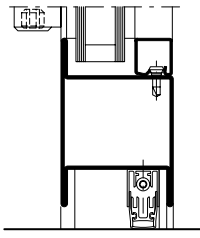

❷ Schloss mit Obenverriegelung
 Serrure avec verrouillage supérieur
 Lock with top locking point

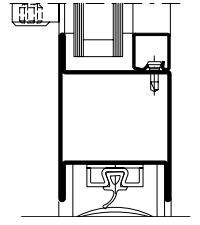
❸ Mehrfachverriegelungs-Schloss
 Serrure à verrouillage multiple
 Multipoint lock

Zweiflügelige Türen,
 auswärts öffnend,
 Flügelhöhe ≤ 2200 mm

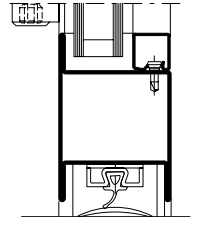
Porte à deux vantaux,
 ouvrant vers l'extérieur,
 hauteur du vantail ≤ 2200 mm

Double leaf door,
 outward opening,
 leaf height ≤ 2200 mm

Variante	Beschlag Ferrure Fitting	 EN 12207	 EN 12208	 EN 12210				
Anschlagdichtung Joint de butée Rebate gasket 	Beschlag Ferrure Fitting	 EN 12207	 EN 12208	 EN 12210				
					1	2	1A	C2
					2	2	2A	C2
Doppel-Anschlagdichtung Joint de base double Double rebate gasket 	Beschlag Ferrure Fitting	 EN 12207	 EN 12208	 EN 12210				
					1	2	2A	C2
					2	2	2A	C2
Senkdichtung Joint seuil Drop seal 	Beschlag Ferrure Fitting	 EN 12207	 EN 12208	 EN 12210				
					1	2	1A	C2
					2	2	2A	C2
Auflaufdichtung Joint de contact Ramp seal 	Beschlag Ferrure Fitting	 EN 12207	 EN 12208	 EN 12210				
					1	2	0	C2
					2	2	0	C2
Auflaufdichtung Joint de contact Ramp seal 	Beschlag Ferrure Fitting	 EN 12207	 EN 12208	 EN 12210				
					3	2	0	C3

1 Fallenriegel-Schloss
 Serrure à mortaiser
 Latch and bolt lock





2 Schloss mit Obenverriegelung
 Serrure avec verrouillage supérieur
 Lock with top locking point

3 Mehrfachverriegelungs-Schloss
 Serrure à verrouillage multiple
 Multipoint lock

Zweiflügelige Türen,
 einwärts öffnend,
 Flügelhöhe ≤ 2200 mm

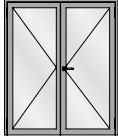
Porte à deux vantaux,
 ouvrant vers l'intérieur,
 hauteur du vantail ≤ 2200 mm

Double leaf door,
 inward opening,
 leaf height ≤ 2200 mm

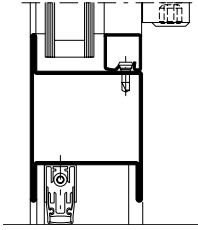
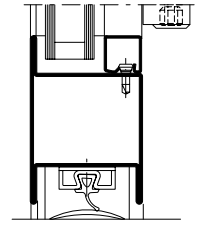
Variante		Beschlag Ferrure Fitting	 EN 12207	 EN 12208	 EN 12210
Senkdichtung Joint seuil Drop seal		❶	2	0	C2
		❷	2	0	C2
		❸	2	0	C3
Auflaufdichtung Joint de contact Ramp seal		❶	2	0	C2
		❷	2	0	C2
		❸	2	0	C3

❶ Fallenriegel-Schloss
 Serrure à mortaiser
 Latch and bolt lock



❷ Schloss mit Obenverriegelung
 Serrure avec verrouillage supérieur
 Lock with top locking point

❸ Mehrfachverriegelungs-Schloss
 Serrure à verrouillage multiple
 Multipoint lock

Zweiflügelige Türen,
 auswärts öffnend,
 Flügelhöhe ≤ 3000 mm

Porte à deux vantaux,
 ouvrant vers l'extérieur,
 hauteur du vantail ≤ 3000 mm

Double leaf door,
 outward opening,
 leaf height ≤ 3000 mm

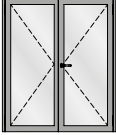
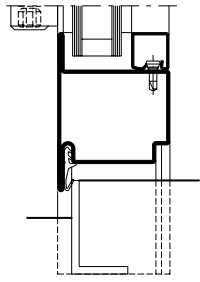
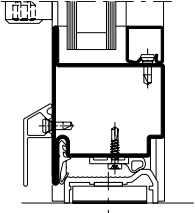
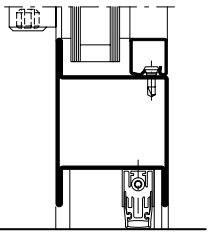
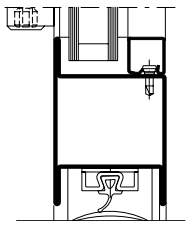
Variante	Beschlag Ferrure Fitting	 EN 12207	 EN 12208	 EN 12210	
					
Anschlagdichtung Joint de butée Rebate gasket		1	0	0	C1
		2	0	0	C1
		3	1	0	C2
Doppel-Anschlagdichtung Joint de base double Double rebate gasket		1	1	0	C1
		2	1	0	C1
		3	2	0	C2
Senkdichtung Joint seuil Drop seal		1	0	0	C1
		2	0	0	C1
		3	1	0	C2
Auflaufdichtung Joint de contact Ramp seal		1	0	0	C1
		2	0	0	C1
		3	1	0	C2

1 Fallenriegel-Schloss
 Serrure à mortaiser
 Latch and bolt lock





2 Schloss mit Obenverriegelung
 Serrure avec verrouillage supérieur
 Lock with top locking point

3 Mehrfachverriegelungs-Schloss
 Serrure à verrouillage multiple
 Multipoint lock

**Zweiflügelige Türen,
 einwärts öffnend,
 Flügelhöhe ≤ 3000 mm**

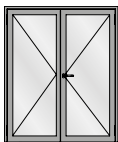
**Porte à deux vantaux,
 ouvrant vers l'intérieur,
 hauteur du vantail ≤ 3000 mm**

**Double leaf door,
 inward opening,
 leaf height ≤ 3000 mm**

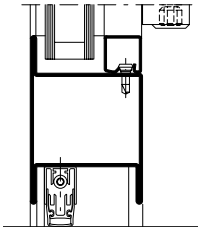
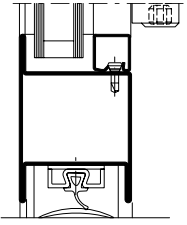
Variante		Beschlag Ferrure Fitting	 EN 12207	 EN 12208	 EN 12210
Senkdichtung Joint seuil Drop seal		1	0	0	C1
		2	0	0	C1
		3	1	0	C2
Auflaufdichtung Joint de contact Ramp seal		1	0	0	C1
		2	0	0	C1
		3	1	0	C2

U_f-Werte
(nach EN ISO 10077-2:2018-01)

Valeurs U_f
(selon EN ISO 10077-2:2018-01)

U_f values
(according to
EN ISO 10077-2:2018-01)

Auf den folgenden Seiten
finden Sie die U_f-Werte für die
verschiedenen Anwendungen von
Jansen-Economy 60.

Vous trouverez les valeurs U_f
pour les différentes applications
Jansen-Economy 60 dans les
pages qui suivent.

On the following pages you
will find the U_f values for the
various applications for
Jansen-Economy 60.

Sie basieren auf folgenden
Grundlagen:

Elles se basent sur les principes
suivants:

They are based on the following:

Stahl

- Profile bandverzinkter Stahl,
unbeschichtet
- Stahl-Glasleisten
- Trockenverglasung
- Nassverglasung

Acier

- Profilés en bande d'acier zingué,
sans revêtement
- Parcloses en acier
- Vitrage à sec
- Vitrage à mastic

Steel

- Strip galvanised steel profiles,
uncoated
- Steel glazing beads
- Glazing with dry glazing
- Glazing with sealing

U_f-Werte
 (nach EN ISO 10077-2:2018-01)

Valeurs U_f
 (selon EN ISO 10077-2:2018-01)

U_f values
 (according to EN ISO 10077-2:2018-01)

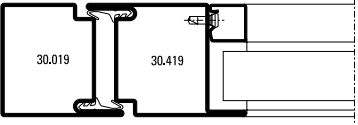
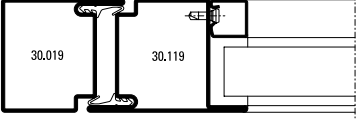
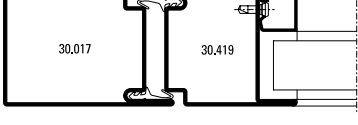
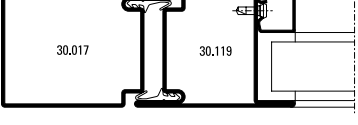
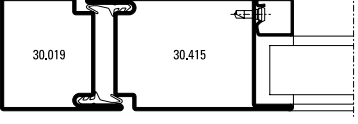
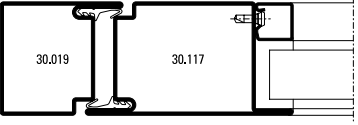
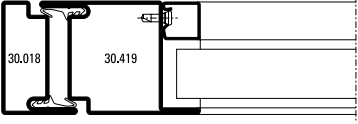
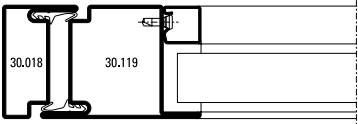
	Füllelementstärken Elements de remplissages Infill elements > 24 mm
	5,5 W/m²K
	5,6 W/m²K
	5,3 W/m²K
	5,3 W/m²K
	5,3 W/m²K
	5,3 W/m²K
	5,6 W/m²K
	5,7 W/m²K

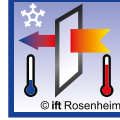
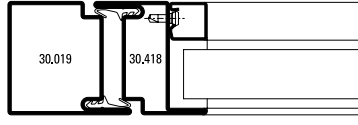
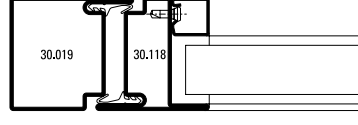
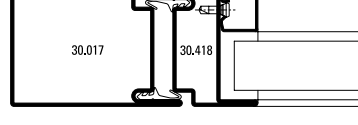
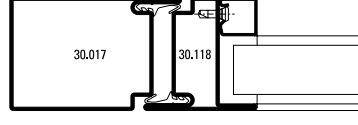
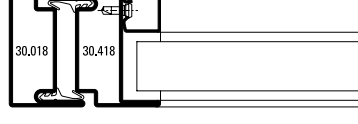
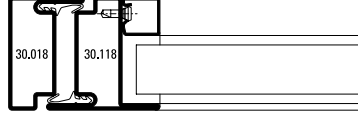
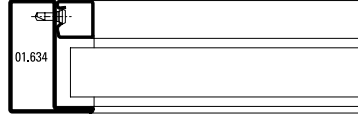
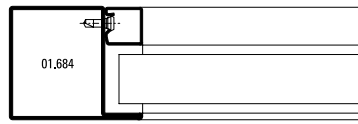
	Füllelementstärken Elements de remplissages Infill elements > 24 mm
	5,7 W/m²K
	5,8 W/m²K
	5,5 W/m²K
	5,5 W/m²K
	6,0 W/m²K
	6,1 W/m²K
	6,9 W/m²K
	6,1 W/m²K

U_f-Werte
 (nach EN ISO 10077-2:2018-01)

Valeurs U_f
 (selon EN ISO 10077-2:2018-01)

U_f values
 (according to EN ISO 10077-2:2018-01)

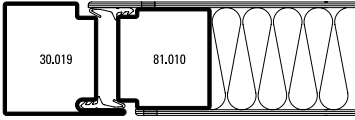
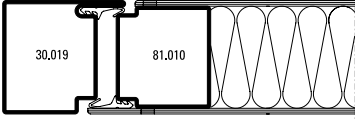
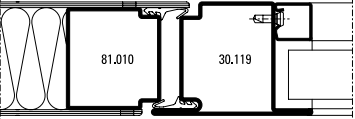
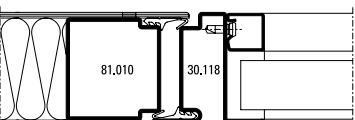
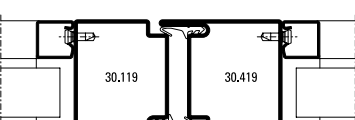
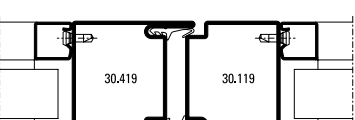
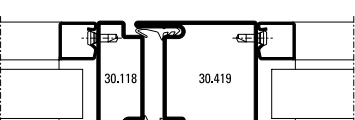
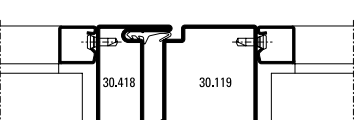
	Füllelementstärken Elements de remplissages Infill elements > 24 mm
	5,3 W/m²K
	5,3 W/m²K
	5,7 W/m²K
	6,0 W/m²K
	5,8 W/m²K
	5,8 W/m²K
	6,1 W/m²K
	6,1 W/m²K

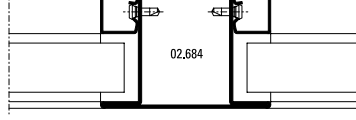
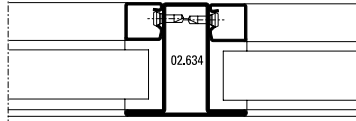
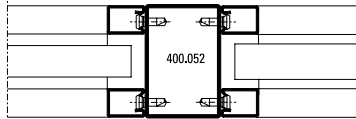
	Füllelementstärken Elements de remplissages Infill elements > 24 mm
	6,3 W/m²K
	7,2 W/m²K
	6,4 W/m²K*

- * Nassverglasung
- * Vitrage à mastic
- * Glazing with sealing

U_f-Werte
 (nach EN ISO 10077-2:2018-01)

Valeurs U_f
 (selon EN ISO 10077-2:2018-01)

U_f values
 (according to EN ISO 10077-2:2018-01)

 © ift Rosenheim	Füllelementstärken Elements de remplissages Infill elements > 24 mm
	4,4 W/m²K

 © ift Rosenheim	Füllelementstärken Elements de remplissages Infill elements > 24 mm
	6,1 W/m²K

	5,6 W/m²K
--	------------------

 © ift Rosenheim	Füllelementstärken Elements de remplissages Infill elements > 24 mm
	6,8 W/m²K
	5,6 W/m²K



Schallschutz

Ausführungsvarianten

Die nachfolgende Typenübersicht ergibt einen Überblick über die beurteilten Varianten.

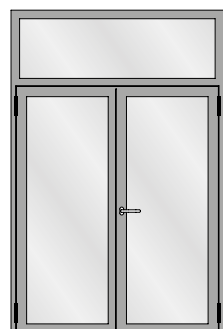
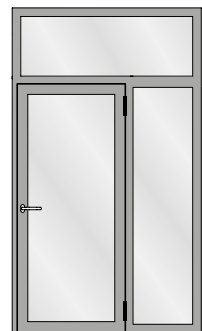
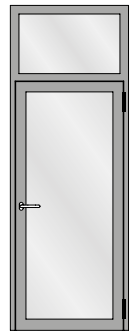
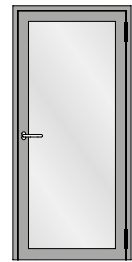

Isolation phonique

Modèles

L'aperçu des types suivant fournit une vue d'ensemble des variantes examinées.

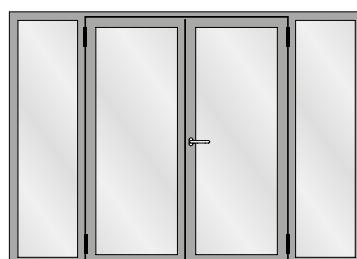
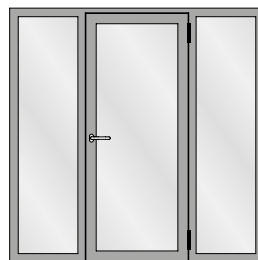
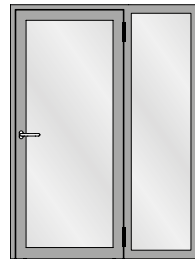
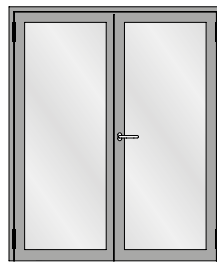

Sound insulation

Design range

The following overview of types provides an overview of the evaluated designs.

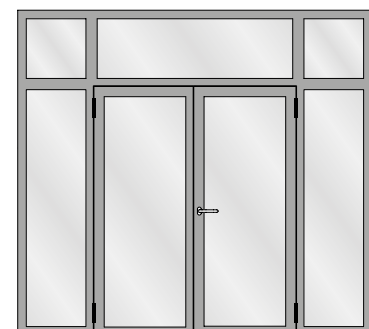
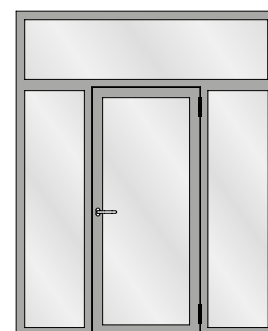

Schallschutz

Isolation phonique

Sound insulation

Tabelle A1

Korrekturtabelle für Jansen-Economy-Türen mit Glasfüllungen

Tableau A1

Tableau de correction pour les portes Jansen-Economy avec vitrage

Table A1

Correction table for Jansen-Economy doors with glass

	1	2	3	4	5	6	7	8	9	10	11
	Türe mit zwei absenkba- ren Bodendichtungen Porte avec deux joint seuil automatique Door with two threshold gaskets that can be lowered	Glas Verre Glass	Korrekturen Corrections Corrections								
	$R_{w(C, Ctr)}$ dB	$R_{w, P, Glas}$ dB	K_S dB	K_{FV} dB	K_{Nass} dB	K_{1aB} dB	$K_{W/S}$ dB	$K_{G 0,4}$ dB	$K_{G 1,8}$ dB	$K_{G 2,6}$ dB	$K_{G 3,2}$ dB
1	32 (-1; -5)	31	0	-1	0	0	0	0	-1	-2	-3
2	33 (-1; -5)	32	0	-1	0	0	0	0	-1	-2	-3
3	35 (-1; -5)	34	0	-1	0	0	0	0	-1	-2	-3
4	36 (-2; -5)	35	0	-1	-1	0	0	0	-1	-2	-3
5	37 (-2; -5)	37	0	0	-1	0	-1	0	-1	-2	-3
6	38 (-2; -5)	39	0	0	-1	-1	-1	0	-1	-2	-3
7	39 (-2; -5)	40	0	0	-1	-1	-1	0	-1	-2	-3
8	40 (-2; -5)	41	0	0	-1	-1	-2	-1	-1	-2	-3
9	41 (-2; -5)	42	0	0	-1	-1	-2	-2	-1	-2	-3
10	42 (-2; -5)	43	-1	0	-1	-1	-2	-2	-1	-2	-3
11	42 (-2; -5)	44	-1	0	-1	-1	-2	-2	-1	-2	-3
12	43 (-2; -5)	45	-1	+1	-1	-1	-3	-3	-1	-2	-3
13	44 (-2; -5)	49	-1	+1	-1	-2	-3	-3	-1	-2	-3

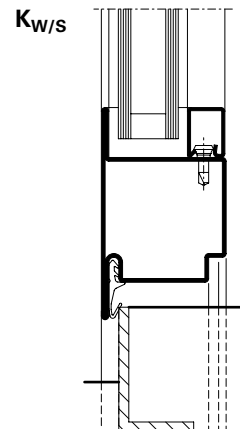
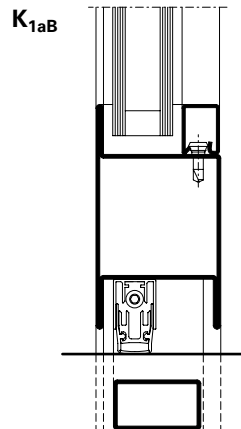
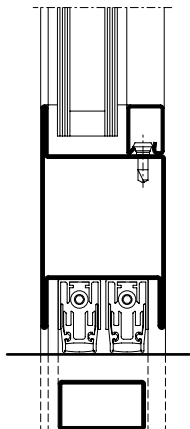

Schallschutz

Isolation phonique

Sound insulation

Der aus der Tabelle A1 abzulesende Wert für die Schalldämmung $R_{w, Tür}$ beträgt:

La valeur à relever sur le tableau A1 concernant l'isolement contre les sons aériens $R_{w, Porte}$ est la suivante:

The value taken from table A1 for the sound insulation $R_{w, Door}$ is:

$$R_{w, Tür} = R_w + K_S + K_{FV} + K_{Nass} + K_{1aB} + K_{W/S} + K_{Band} + K_{G 0,4} + K_{G 1,8} + K_{G 2,6} + K_{G 3,2} \text{ dB}$$

- R_w** bewertetes Schalldämm-Mass der Türe in Abhängigkeit von der Schalldämmung $R_{w,P, Glas}$
- $R_{w,P, Glas}$** bewertetes Schalldämm-Mass der Verglasung (Prüfwert nach ISO 140-3, mit Prüfnachweis einer PÜZ-Stelle). Alternativ können Tabellenwerte nach DIN EN 12758, Abschnitt 6 verwendet werden
- K_S** Korrekturwert für zweiflügelige Türen
- K_{FV}** Korrekturwert für Festverglasungen mit erhöhtem Scheibenanteil
- K_{Nass}** Korrekturwert für Nassverglasung
- K_{1aB}** Korrekturwert für Türen mit einer absenkbaren Bodendichtung
- K_{Band}** Korrekturwert bei Verwendung von Anschlagbändern, die eine Dichtungsebene unterbrechen ($K_{Band} = - 0,5 \text{ dB pro Band}$)
- $K_{W/S}$** Korrekturwert für Türen mit einer Anschlagsschwelle
- $K_{G 0,4}$** Korrekturwert für Einzelscheiben mit einer Glasfläche $\leq 0,4 \text{ m}^2$. Die Korrektur gilt auch für Konstruktionen mit glasteilenden Sprossen.
- $K_{G 1,8}$** Korrekturwert für Einzelscheiben mit einer Glasfläche $\geq 1,8 \text{ m}^2$
- $K_{G 2,6}$** Korrekturwert für Einzelscheiben mit einer Glasfläche $\geq 2,6 \text{ m}^2$
- $K_{G 3,2}$** Korrekturwert für Einzelscheiben mit einer Glasfläche $\geq 3,2 \text{ m}^2$

- R_w** Mesure d'isolement contre les sons aériens des portes évaluée suivant l'isolement phonique $R_{w,P, Glas}$
- $R_{w,P, Glas}$** Cote d'isolement acoustique du vitrage évalué (valeur contrôlée selon ISO 140-3 avec certificat d'un bureau de contrôle, de surveillance ou de certification). Il est également possible d'utiliser les valeurs selon le tableau DIN EN 12758, section 6
- K_S** Valeur de correction pour portes à deux vantaux
- K_{FV}** Valeur de correction pour vitrages fixes à fort pourcentage de vitre
- K_{Nass}** Valeur de correction pour vitrage avec mastic
- K_{1aB}** Valeur de correction pour portes avec un joint seuil automatique
- K_{Band}** Valeur corrective en cas d'utilisation de paumelles qui interrompent un plan d'étanchéité ($K_{Band} = - 0,5 \text{ dB par paumelle}$)
- $K_{W/S}$** Valeur de correction pour portes avec un seuil de butée
- $K_{G 0,4}$** Valeur de correction pour vitres individuelles avec une surface vitrée $\leq 0,4 \text{ m}^2$. La correction s'applique aussi aux constructions à meneaux séparant les vitres.
- $K_{G 1,8}$** Valeur de correction pour vitres individuelles avec surface vitrée $\geq 1,8 \text{ m}^2$
- $K_{G 2,6}$** Valeur de correction pour vitres individuelles avec surface vitrée $\geq 2,6 \text{ m}^2$
- $K_{G 3,2}$** Valeur de correction pour vitres individuelles avec surface vitrée $\geq 3,2 \text{ m}^2$

- R_w** Airborne sound reduction index of doors depending on the sound insulation $R_{w,P, Glas}$
- $R_{w,P, Glas}$** Airborne sound reduction index (test value in accordance with ISO 140-3, with a test certificate from a recognised testing, inspection or certification body). Alternatively, the tabulated values in DIN EN 12758, Section 6 may be used
- K_S** Correction value for double-leaf doors
- K_{FV}** Correction value for fixed glazing with increased proportion of pane
- K_{Nass}** Correction value for glazing with sealing
- K_{1aB}** Correction value for doors with a threshold gasket that can be lowered
- K_{Band}** Correction value when using hinges that interrupt a sealing plane ($K_{Band} = - 0.5 \text{ dB per hinge}$)
- $K_{W/S}$** Correction value for doors with a rebate threshold
- $K_{G 0,4}$** Correction value for single panes with a glass area $\leq 0,4 \text{ m}^2$. The correction also applies to buildings with glazing bars
- $K_{G 1,8}$** Correction value for single panes with a glass area $\geq 1,8 \text{ m}^2$
- $K_{G 2,6}$** Correction value for single panes with a glass area $\geq 2,6 \text{ m}^2$
- $K_{G 3,2}$** Correction value for single panes with a glass area $\geq 3,2 \text{ m}^2$